

## Errata

**Title & Document Type:** 8647A Signal Generator Operation and Service Guide

**Manual Part Number:** 08647-90006

**Revision Date:** March 1984

---

### HP References in this Manual

This manual may contain references to HP or Hewlett-Packard. Please note that Hewlett-Packard's former test and measurement, semiconductor products and chemical analysis businesses are now part of Agilent Technologies. We have made no changes to this manual copy. The HP XXXX referred to in this document is now the Agilent XXXX. For example, model number HP8648A is now model number Agilent 8648A.

### About this Manual

We've added this manual to the Agilent website in an effort to help you support your product. This manual provides the best information we could find. It may be incomplete or contain dated information, and the scan quality may not be ideal. If we find a better copy in the future, we will add it to the Agilent website.

### Support for Your Product

Agilent no longer sells or supports this product. You will find any other available product information on the Agilent Test & Measurement website:

[www.tm.agilent.com](http://www.tm.agilent.com)

Search for the model number of this product, and the resulting product page will guide you to any available information. Our service centers may be able to perform calibration if no repair parts are needed, but no other support from Agilent is available.

---

# Operation and Service Guide

## HP 8647A Signal Generator

### SERIAL NUMBERS

This manual applies directly to all instruments with serial prefix 3247A and 3349A.



HP Part No. 08647-90006  
Printed in USA March 1994

**Notice.** The information contained in this document is subject to change without notice.

Hewlett-Packard makes no warranty of any kind with regard to this material, including but not limited to, the implied warranties of merchantability and fitness for a particular purpose. Hewlett-Packard shall not be liable for errors contained herein or for incidental or consequential damages in connection with the furnishing, performance, or use of this material.

© Copyright Hewlett-Packard Company 1994

All Rights Reserved. Reproduction, adaptation, or translation without prior written permission is prohibited, except as allowed under the copyright laws.

1400 Fountaingrove Parkway, Santa Rosa CA, 95403-1799, USA

Reproduced with Permission, Courtesy of Agilent Technologies, Inc.

---

## **Certification**

Hewlett-Packard Company certifies that this product met its published specifications at the time of shipment from the factory. Hewlett-Packard further certifies that its calibration measurements are traceable to the United States National Institute of Standards and Technology, to the extent allowed by the Institute's calibration facility, and to the calibration facilities of other International Standards Organization members.

## **Regulatory Information**

The regulatory information is in Chapter 4, "Specifications."

---

## **Warranty**

This Hewlett-Packard instrument product is warranted against defects in material and workmanship for a period of one year from date of shipment. During the warranty period, Hewlett-Packard Company will, at its option, either repair or replace products which prove to be defective.

For warranty service or repair, this product must be returned to a service facility designated by Hewlett-Packard. Buyer shall prepay shipping charges to Hewlett-Packard and Hewlett-Packard shall pay shipping charges to return the product to Buyer. However, Buyer shall pay all shipping charges, duties, and taxes for products returned to Hewlett-Packard from another country.

Hewlett-Packard warrants that its software and firmware designated by Hewlett-Packard for use with an instrument will execute its programming instructions when properly installed on that instrument. Hewlett-Packard does not warrant that the operation of the instrument, or software, or firmware will be uninterrupted or error-free.

### **LIMITATION OF WARRANTY**

The foregoing warranty shall not apply to defects resulting from improper or inadequate maintenance by Buyer, Buyer-supplied software or interfacing, unauthorized modification or misuse, operation outside of the environmental specifications for the product, or improper site preparation or maintenance.

**NO OTHER WARRANTY IS EXPRESSED OR IMPLIED. HEWLETT-PACKARD SPECIFICALLY DISCLAIMS THE IMPLIED WARRANTIES OF MERCHANTABILITY AND FITNESS FOR A PARTICULAR PURPOSE.**

### **EXCLUSIVE REMEDIES**

**THE REMEDIES PROVIDED HEREIN ARE BUYER'S SOLE AND EXCLUSIVE REMEDIES. HEWLETT-PACKARD SHALL NOT BE LIABLE FOR ANY DIRECT, INDIRECT, SPECIAL, INCIDENTAL, OR CONSEQUENTIAL DAMAGES, WHETHER BASED ON CONTRACT, TORT, OR ANY OTHER LEGAL THEORY.**

---

## Assistance

*Product maintenance agreements and other customer assistance agreements are available for Hewlett-Packard products. For any assistance, contact your nearest Hewlett-Packard Sales and Service Office. Refer to the list of Sales and Service Offices on the following page.*

## Hewlett-Packard Sales and Service Offices

### US FIELD OPERATIONS HEADQUARTERS

Hewlett-Packard Company  
19320 Pruneridge Avenue  
Cupertino, CA 95014, USA  
(800) 752-0900

#### California

Hewlett-Packard Co.  
1421 South Manhattan Ave.  
Fullerton, CA 92631  
(714) 999-6700

Hewlett-Packard Co.  
301 E. Evelyn  
Mountain View, CA 94041  
(415) 694-2000

#### Colorado

Hewlett-Packard Co.  
24 Inverness Place, East  
Englewood, CO 80112  
(303) 649-5000

#### Georgia

Hewlett-Packard Co.  
2000 South Park Place  
Atlanta, GA 30339  
(404) 955-1500

#### Illinois

Hewlett-Packard Co.  
5201 Tollview Drive  
Rolling Meadows, IL 60008  
(708) 255-9800

#### New Jersey

Hewlett-Packard Co.  
150 Green Pond Road  
Rockaway, NJ 07866  
(201) 627-6400

#### Texas

Hewlett-Packard Co.  
930 E. Campbell Rd.  
Richardson, TX 75081  
(214) 231-6101

### EUROPEAN OPERATIONS HEADQUARTERS

Hewlett-Packard S.A.  
150, Route du Nant-d'Avril  
1217 Meyrin 2/Geneva  
Switzerland  
(41 22) 780.8111

#### France

Hewlett-Packard France  
1 Avenue Du Canada  
Zone D'Activite De Courtaboeuf  
F-91947 Les Ulis Cedex  
France  
(33 1) 69 82 60 60

#### Germany

Hewlett-Packard GmbH  
Hewlett-Packard Strasse  
6380 Bad Homburg v.d.H  
Germany  
(49 6172) 16-0

#### Great Britain

Hewlett-Packard Ltd.  
Eskdale Road, Winnersh Triangle  
Wokingham, Berkshire RG11 5DZ  
England  
(44 734) 696622

### INTERCON OPERATIONS HEADQUARTERS

Hewlett-Packard Company  
3495 Deer Creek Rd.  
Palo Alto, California 94304-1316  
(415) 857-5027

#### Australia

Hewlett-Packard Australia Ltd.  
31-41 Joseph Street  
Blackburn, Victoria 3130  
(61 3) 895-2895

#### Canada

Hewlett-Packard (Canada) Ltd.  
17500 South Service Road  
Trans-Canada Highway  
Kirkland, Quebec H9J 2X8  
Canada  
(514) 697-4232

#### Japan

Yokogawa-Hewlett-Packard Ltd.  
1-27-15 Yabe, Sagamihara  
Kanagawa 229, Japan  
(81 427) 59-1311

#### China

China Hewlett-Packard, Co.  
38 Bei San Huan XI Road  
Shuang Yu Shu  
Hai Dian District  
Beijing, China  
(86 1) 256-6888

#### Singapore

Hewlett-Packard Singapore  
Pte. Ltd.  
1150 Depot Road  
Singapore 0410  
(65) 273 7388

#### Taiwan

Hewlett-Packard Taiwan  
8th Floor, H-P Building  
337 Fu Hsing North Road  
Taipei, Taiwan  
(886 2) 712-0404

---

## Safety Notes

The following safety notes are used throughout this manual. Familiarize yourself with each of the notes and its meaning before operating this instrument.

---

### Caution

Caution denotes a hazard. It calls attention to a procedure that, if not correctly performed or adhered to, would result in damage to or destruction of the instrument. Do not proceed beyond a caution sign until the indicated conditions are fully understood and met.

---

### Warning

**Warning denotes a hazard. It calls attention to a procedure which, if not correctly performed or adhered to, could result in injury or loss of life. Do not proceed beyond a warning note until the indicated conditions are fully understood and met.**

---

---

## Instrument Markings

The following markings and caution and warning labels are used on the instrument. Be sure to observe all cautions and warnings.

---

### Instruction Manual



The **instruction documentation** symbol. The product is marked with this symbol when it is necessary for the user to refer to the instruction in the manual.

---

The CE93 mark shows compliance with European Community 1993 standards.

---

The CSA mark is the Canadian Standards Association safety mark.

---

The ISM1-A mark is a symbol of an Industrial Scientific and Medical Group 1, Class A product.

---

### Warning

**Hazardous voltage always present in this area with instrument power cord connected to ac line.**

---

### Warning

**Hazardous Voltage**

---

**Caution**

---

Hazardous electrical shock. Heat sink is live. Disconnect power supply before servicing.

---

---

**General Safety  
Considerations**

**Warning**

---

No operator serviceable parts inside. Refer servicing to qualified personnel. To prevent electrical shock, do not remove covers.

---

**Warning**

---

If this instrument is used in a manner not specified by Hewlett-Packard Co., the protection provided by the instrument may be impaired.

---

**Warning**

---

For continued protection against fire hazard replace line fuse only with same type and rating (3 A 250 V type F). The use of other fuses or material is prohibited.

---

**Caution**

---

Always use the three-prong ac power cord supplied with this instrument. Failure to ensure adequate earth grounding by not using this cord may cause instrument damage.

---



---

## How to Use This Guide

This guide uses the following convention:

**FRONT-PANEL KEY**

This represents a key physically located on the instrument.

Display

Text in this font represents FREQUENCY, MODULATION, and AMPLITUDE displays.

---

## Documentation Description



This guide contains the information required to operate, calibrate, and repair the signal generator to the assembly level. Included are the following:

- a quick overview of the signal generator
- examples of typical operation
- a reference section that describes all operation features
- explanations of error messages displayed on the signal generator
- installation instructions
- tables of specifications
- theory of operation of the signal generator
- troubleshooting procedures to identify failed assemblies
- replaceable part numbers
- adjustments required after repair or performance test failure
- performance tests to test the instrument to specifications

# Contents

---

<b>1. Operation</b>	
Quick Overview . . . . .	1-2
1. Power Key . . . . .	1-2
2. Display Contrast . . . . .	1-2
3. Function and Data Keys . . . . .	1-2
4. Increment Set Keys . . . . .	1-2
5. Knobs . . . . .	1-2
6. MEMORY . . . . .	1-3
7. Modulation Source . . . . .	1-3
<b>1a. Operation Examples</b>	
Getting Started . . . . .	1a-1
Operation Examples . . . . .	1a-1
Setting the RF Output Signal . . . . .	1a-2
Setting the Frequency . . . . .	1a-2
Setting the Amplitude . . . . .	1a-2
Turn on the RF Output . . . . .	1a-3
Setting the Modulation . . . . .	1a-3
Incrementing or Decrementing the RF Output Signal . . . . .	1a-4
Preliminary Steps . . . . .	1a-4
Using the Knob . . . . .	1a-4
Using the Increment keys . . . . .	1a-5
Using the Memory Registers . . . . .	1a-6
Saving Instrument Settings in Register Sequences . . . . .	1a-7
Selecting the Sequence . . . . .	1a-7
Saving Settings in Registers . . . . .	1a-7
Checking the Sequence . . . . .	1a-9
Checking a Different Sequence . . . . .	1a-9
Deleting a Register from the Sequence . . . . .	1a-11
Selecting the Sequence . . . . .	1a-11
Deleting a Register . . . . .	1a-11
Renumbering the Registers in a Sequence . . . . .	1a-13
Decreasing the Register Number . . . . .	1a-13
Checking the Sequence . . . . .	1a-14
Inserting a Register in a Sequence . . . . .	1a-15
Saving a New Register . . . . .	1a-16
Offsetting the RF Output from a Reference . . . . .	1a-17
Setting the Reference Value . . . . .	1a-17
Offsetting the RF Output . . . . .	1a-18
Turning the Reference Mode Off or On . . . . .	1a-18
Setting a New Reference Value . . . . .	1a-19
Holding the Output Attenuator Range . . . . .	1a-20
Set the Amplitude Level . . . . .	1a-20
Holding the Attenuator . . . . .	1a-20
Adjusting the Amplitude . . . . .	1a-21

<b>1b. Operation Reference</b>	
Frequency and Amplitude . . . . .	1b-2
1. Knob . . . . .	1b-2
2. Digit-Select Arrow Keys . . . . .	1b-2
3. REF SET . . . . .	1b-3
Units . . . . .	1b-3
4. REF ON/OFF . . . . .	1b-3
Function . . . . .	1b-4
1. FREQUENCY . . . . .	1b-4
2. AMPLITUDE . . . . .	1b-4
3. FM AM $\phi$ M . . . . .	1b-4
INCREMENT SET . . . . .	1b-5
1. INCR SET . . . . .	1b-5
Data . . . . .	1b-6
1. MHz/dBm . . . . .	1b-6
Units Conversion . . . . .	1b-6
2. Backspace . . . . .	1b-6
3. emf . . . . .	1b-6
4. $\pm$ . . . . .	1b-6
Instrument Preset . . . . .	1b-7
POWER  . . . . .	1b-7
POWER  . . . . .	1b-7
HP-IB . . . . .	1b-9
1. ADRS . . . . .	1b-9
2. LOCAL . . . . .	1b-9
MEMORY . . . . .	1b-10
1. SAV . . . . .	1b-11
2. REG . . . . .	1b-12
3. Register Recall Arrows . . . . .	1b-12
4. SEQ . . . . .	1b-13
5. DEL . . . . .	1b-14
Renumbering the Registers . . . . .	1b-14
Modulation Source . . . . .	1b-15
1. MOD ON/OFF . . . . .	1b-16
2. INT 400 Hz INT 1 kHz . . . . .	1b-16
3. EXT AC EXT DC . . . . .	1b-16
4. 1 kHz + EXT DC . . . . .	1b-17
Setting the Modulation Level . . . . .	1b-17
5. MOD INPUT/OUTPUT . . . . .	1b-17
RF OUTPUT . . . . .	1b-18
1. RF ON/OFF . . . . .	1b-18
2. ATTN HOLD . . . . .	1b-18
Vernier Ranges . . . . .	1b-18
3. RF OUTPUT . . . . .	1b-19
Rear Panel . . . . .	1b-20
1. 10 MHz REF INPUT and OUTPUT . . . . .	1b-20
2. DISPLAY CONTRAST . . . . .	1b-20
3. AUXILIARY INTERFACE . . . . .	1b-21
4. Line Voltage Connector . . . . .	1b-21
5. HP-IB Connector . . . . .	1b-21
6. TIMEBASE ADJUST and Help Switches . . . . .	1b-21
Remote Interface (Accessory) . . . . .	1b-22
1. MOD ON/OFF . . . . .	1b-22
2. RF ON/OFF . . . . .	1b-22
3. Sequence Selection Arrows . . . . .	1b-23

4. Register Recall Arrows . . . . .	1b-23
Memory Interface (Accessory) . . . . .	1b-24
1. POWER . . . . .	1b-24
2. Copy Arrow Keys . . . . .	1b-25
Making a Copy . . . . .	1b-25
3. BUSY . . . . .	1b-25
<b>1c. Operation Messages</b>	
Front Panel Operation Messages . . . . .	1c-1
HP-IB - Command Errors . . . . .	1c-5
HP-IB Execution Errors . . . . .	1c-7
HP-IB Device-Specific Errors . . . . .	1c-7
HP-IB Query Errors . . . . .	1c-7
Service Messages . . . . .	1c-8
<b>2. HP-IB Programming</b>	
Background . . . . .	2-1
Programming Guidelines . . . . .	2-3
HP-IB Definition . . . . .	2-3
What is Programmable . . . . .	2-3
HP-IB Address . . . . .	2-3
Error Messages . . . . .	2-3
Programming Language . . . . .	2-3
Query . . . . .	2-3
Advanced Programming . . . . .	2-3
Programming Examples . . . . .	2-4
Programming RF Frequency . . . . .	2-4
Programming RF Frequency and FM Modulation . . . . .	2-4
Querying RF Frequency . . . . .	2-5
Programming RF Amplitude . . . . .	2-5
HP-IB Status Reporting . . . . .	2-8
External Modulation Input Level Status . . . . .	2-9
Example: Check the Condition of Modulation Input (High or Low) . . . . .	2-9
Example: Generate a Service Request for External Modulation Input (High or Low) . . . . .	2-10
Reverse Power Protection Status . . . . .	2-11
Example: Check the condition of the RPP . . . . .	2-11
Unspecified Power (Amplitude) Entry Status . . . . .	2-11
Example: Check the Condition of Unspecified Power Entry . . . . .	2-12
HP 8647A SCPI Command Reference . . . . .	2-13
AM Subsystem . . . . .	2-14
CAL Subsystem . . . . .	2-14
FM Subsystem . . . . .	2-15
FREQUENCY Subsystem . . . . .	2-16
OUTPut Subsystem . . . . .	2-16
PM Subsystem . . . . .	2-17
POWER Subsystem . . . . .	2-18
STATus Subsystem . . . . .	2-19
SYSTEM Subsystem . . . . .	2-20
HP-IB Capabilities . . . . .	2-21
HP-IB Connector Information . . . . .	2-22

<b>3. Installation</b>	
Unpacking Your Signal Generator . . . . .	3-1
Connecting AC Power . . . . .	3-1
Power Requirements . . . . .	3-2
Replacing the Fuse . . . . .	3-2
Turning On the Signal Generator . . . . .	3-5
Connecting to Other Instruments . . . . .	3-5
Storing the Signal Generator . . . . .	3-5
Shipping the Signal Generator . . . . .	3-6
<b>4. Specifications</b>	
Frequency Specifications . . . . .	4-2
Internal Reference Oscillator . . . . .	4-2
Output . . . . .	4-3
Spectral Purity . . . . .	4-3
Frequency Modulation . . . . .	4-4
Phase Modulation . . . . .	4-5
Amplitude Modulation . . . . .	4-5
Modulation Source . . . . .	4-6
Remote Programming . . . . .	4-6
Environmental . . . . .	4-6
General . . . . .	4-6
Regulatory Information . . . . .	4-8
ISO 9002 Compliant . . . . .	4-8
Statement of Compliance . . . . .	4-8
Noise Declaration . . . . .	4-8
<b>5. Service</b>	
Shipping Your Instrument Back to Hewlett-Packard . . . . .	5-1
Operation Verification Software . . . . .	5-2
<b>5a. Theory of Operation</b>	
Introduction . . . . .	5a-1
Overview . . . . .	5a-2
A1 Front Panel . . . . .	5a-2
A2 Power Supply . . . . .	5a-3
A3 Motherboard . . . . .	5a-3
A4 Reference . . . . .	5a-4
A5 Sig Gen Synth . . . . .	5a-4
A6 Output . . . . .	5a-4
A7 Attenuator . . . . .	5a-5
<b>5b. Troubleshooting Information</b>	
Introduction . . . . .	5b-1
Troubleshooting Checklist . . . . .	5b-2
AC Mains (line) Fuse Removal . . . . .	5b-3
To Remove the Fuse . . . . .	5b-3
Modulation Testpoints and Power Supply LEDs . . . . .	5b-4
Power Supply Distribution . . . . .	5b-5

**5c. Service Error Messages**

**6. Replaceable Parts**

Introduction . . . . .	6-1
Assembly Replacements . . . . .	6-1

**7. Adjustments**

Internal Timebase Adjustment . . . . .	7-1
Recommended Equipment (or equivalent) . . . . .	7-1
Procedure . . . . .	7-1

**8. Performance Tests**

Calibration Cycle . . . . .	8-1
Required Test Equipment . . . . .	8-2
FM Accuracy Performance Test . . . . .	8-3
FM Distortion Performance Test . . . . .	8-4
AM Accuracy Performance Test . . . . .	8-6
AM Distortion Performance Test . . . . .	8-7
Phase Modulation Accuracy Performance Test . . . . .	8-9
Phase Modulation Distortion Performance Test . . . . .	8-10
Residual FM Performance Test . . . . .	8-12
Harmonics Performance Test . . . . .	8-14
Spurious Performance Test . . . . .	8-15
DC FM Frequency Error Performance Test . . . . .	8-16
RF Level Accuracy Performance Test . . . . .	8-17
CW Frequency Accuracy Performance Test (Option 1E5 Only) . . . . .	8-18
Test Record . . . . .	8-19

**Index**

## Figures

---

2-1. HP 8647A Status Register Model . . . . .	2-8
3-1. Replacing the Fuse . . . . .	3-3
3-2. Power Cable and Mains Plug . . . . .	3-4
5a-1. Simplified Block Diagram . . . . .	5a-1
5b-1. Removing the Fuse Housing . . . . .	5b-3
8-1. FM Accuracy Equipment Setup . . . . .	8-3
8-2. FM Distortion Equipment Setup . . . . .	8-4
8-3. AM Accuracy Equipment Setup . . . . .	8-6
8-4. AM Distortion Equipment Setup . . . . .	8-7
8-5. Phase Modulation Distortion Equipment Setup . . . . .	8-9
8-6. Phase Modulation Distortion Equipment Setup . . . . .	8-10
8-7. Residual FM Equipment Setup . . . . .	8-12
8-8. Harmonics Equipment Setup . . . . .	8-14
8-9. Spurious Equipment Setup . . . . .	8-15
8-10. DC FM Frequency Error Equipment Setup . . . . .	8-16
8-11. RF Level Accuracy Equipment Setup . . . . .	8-17
8-12. CW Frequency Accuracy Equipment Setup . . . . .	8-18

## Tables

---

2-1. Programming Command Statements and Descriptions . . . . .	2-6
2-2. Dictionary of Terms . . . . .	2-13
2-3. IEEE 488.2 Capabilities . . . . .	2-21
3-1. Voltage Ranges for Nominal Voltage Values . . . . .	3-2
5a-1. A1 Front Panel (keyboard) . . . . .	5a-3
6-1. Replaceable Parts . . . . .	6-2
8-1. HP 8647A Test Record . . . . .	8-19
8-2. HP 8647A Test Record . . . . .	8-20
8-3. FM Accuracy Performance Test . . . . .	8-21
8-4. FM Distortion Performance Test . . . . .	8-22
8-5. AM Accuracy Performance Test . . . . .	8-23
8-6. AM Distortion Performance Test . . . . .	8-25
8-7. Phase Modulation Accuracy Performance Test . . . . .	8-26
8-8. Phase Modulation Distortion Performance Test . . . . .	8-27
8-9. Residual FM Performance Test . . . . .	8-28
8-10. Harmonics Performance Test . . . . .	8-29
8-11. Spurious Performance Test . . . . .	8-32
8-12. DC FM Frequency Error Performance Test . . . . .	8-33
8-13. RF Level Accuracy Performance Test . . . . .	8-34
8-14. CW Frequency Accuracy Performance Test (Option 1E5 Only) . . . . .	8-39

# Operation

---

“Operation” contains the following information:

- |                         |  |
|-------------------------|--|
| 1. Operation            | Provides a quick overview of the instrument's operation.                         |
| 1a. Operation Examples  | Provides examples to help you learn how to operate the instrument.               |
| 1b. Operation Reference | Provides quick access to information about each of the instrument's functions.   |
| Operation Messages      | Provides information about both front-panel and HP-IB remote operation messages. |

---

**Note**

For information about service messages numbered 500 and above, refer to Chapter 5c, “Service Error Messages.”

---



## Quick Overview

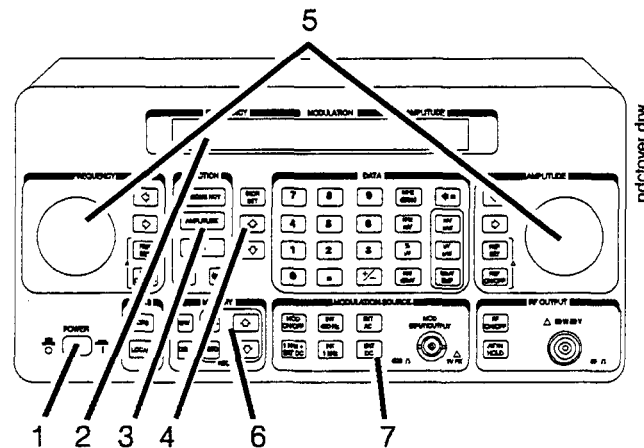

- 1. Power Key** Press **POWER** to power-up the instrument. The instrument powers up to the same state it was in when power was turned off, except that the RF output will be turned off; press the **RF ON/OFF** key to turn it on.
- 2. Display Contrast** Display contrast is an adjustment that is located on the rear panel. It allows you to adjust contrast for the front-panel display. Turn the adjustment to optimize the display for viewing it from above, below, or straight on. If the display is blank, first attempt to adjust the display contrast adjustment before returning the instrument for service.
- 3. Function and Data Keys** The keys in the **FUNCTION** and **DATA** blocks allow you to enter values for setting the frequency, amplitude, and modulation level of the RF output signal.
- 4. Increment Set Keys** When you press a **FUNCTION** key, that function becomes the active function. Press **INCR SET** to view or change the increment value for the active function. Press the **↑** or **↓** key at any time to change the active function setting by the increment value.
- 5. Knobs** The knobs are always active when the instrument is in local (front panel) control. Turn them to increase or decrease the frequency or amplitude of the RF output. Press **←** or **→**, next to each knob, to adjust the knob's resolution.  
  
Press **REF SET**, next to each knob, to set the displayed value as the reference value and turn on the reference mode. Press **REF ON/OFF** to turn on and off the reference mode without changing the reference value. When the reference mode is on, the displayed value indicates the offset between the reference value and the RF output signal.

## 6. MEMORY

Memory registers allow you to save instrument set-ups and recall them whenever you wish. Press **(SAV)** and enter a two-digit register number to save the instrument's current settings. To recall the settings, press **(REG)** and enter the register number. The arrow keys allow you to recall registers in numerical sequence. You can arrange your registers in up to ten different sequences.

The number of the currently selected sequence and the last register selected are always displayed in the lower left corner of the display to help you keep track of where you are in your testing process. The memory register examples provided in Chapter 1a, "Operation Examples," show you how to create a sequence and how to delete or add registers in your sequence.

## 7. Modulation Source

Press **(MOD ON/OFF)** to turn on or off the modulation source. Press **(INT 400 Hz)** or **(INT 1 kHz)** to select one of the internal source tones for modulating the RF output signal. These tones are also available as an output signal at the MOD INPUT/OUTPUT port when they are selected. Press **(EXT AC)** or **(EXT DC)** to ac- or dc-couple an external audio source via the MOD INPUT/OUTPUT port.

Press **(1kHz + EXT DC)** to frequency modulate the RF signal with the internal 1 kHz tone and an external source at the same time. (Additional internal plus external modulation capabilities are available for HP-IB operation.)

## Operation Examples

This section contains operating examples to help you learn how to operate the signal generator. These examples can be performed without any additional equipment.

### Getting Started

If this is the first time you have operated this instrument, perform each of the following examples for a quick introduction to general operation. After you have completed the examples, try operating the instrument's remaining functions on your own. If you have trouble or want additional information on a function, refer to Chapter 1b, "Operation Reference." If a message is displayed that you do not understand, refer to Chapter 1c, "Operation Messages."

### Operation Examples

1. Setting the RF Output Signal
2. Incrementing or Decrementing the RF Output Signal
3. Using the Memory Registers
4. Offsetting the RF Output from a Reference
5. Holding the Output Attenuator Range

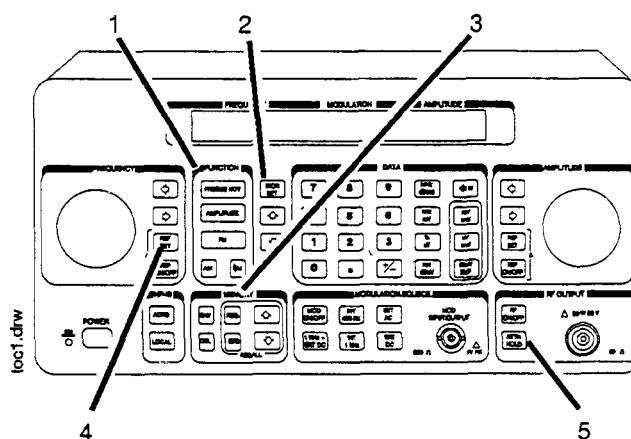

## Setting the RF Output Signal

In this example, you will set the frequency, amplitude, and modulation level of the RF output signal.

### Setting the Frequency

1. Set the frequency to 100 MHz using the keys shown below the instrument diagram.

If you make a mistake while entering a value, press  to correct it.

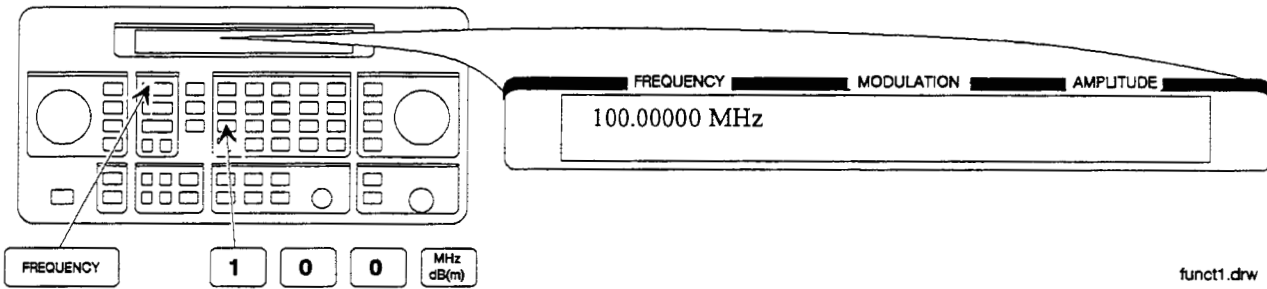

### Setting the Amplitude

2. Set the amplitude to -100 dBm.

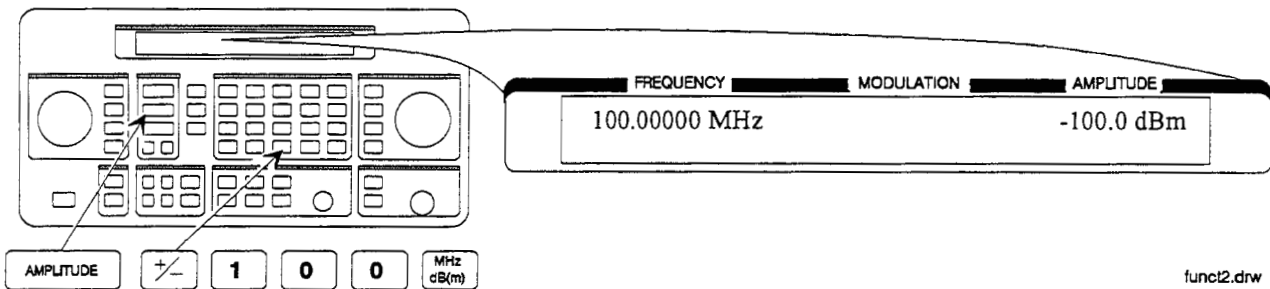

### Turn on the RF Output

3. Press **RF ON/OFF** to turn on the RF output.

RF OFF is displayed below the amplitude setting when the RF output is turned off.

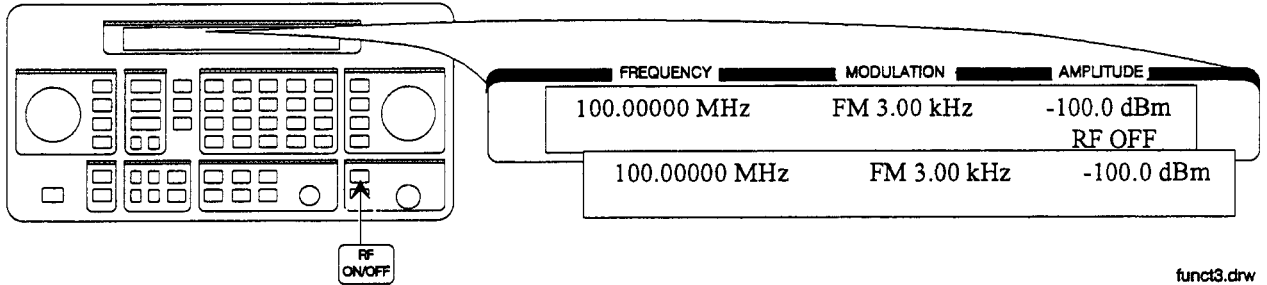

### Setting the Modulation

4. Set the FM deviation to 3 kHz.

The modulation rate is displayed below the deviation setting. Use the MODULATION SOURCE keys when you wish to select a modulation source and turn modulation on or off.

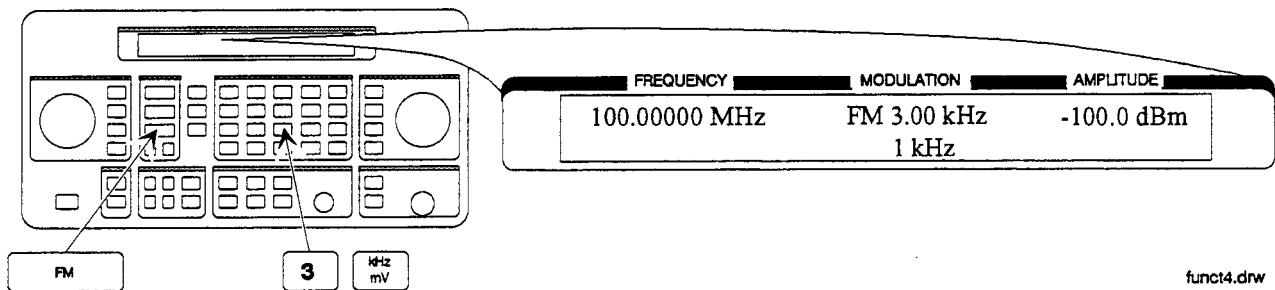

## Incrementing or Decrementing the RF Output Signal

In this example, you will increment the amplitude and frequency of the RF output signal.

### Preliminary Steps

1. If they are not already set, set the frequency to 100 MHz, and the amplitude to  $-100$  dBm.

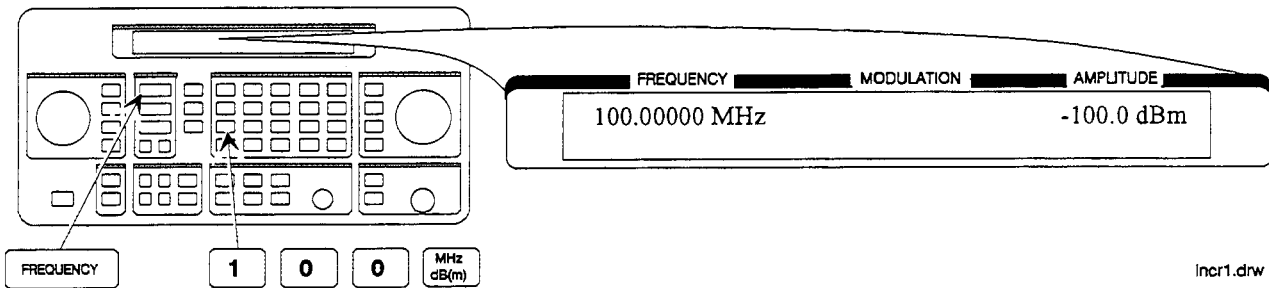

### Using the Knob

2. Increment the amplitude using the knob.

Press  $\leftarrow$  or  $\rightarrow$  when you wish to adjust the increment resolution.

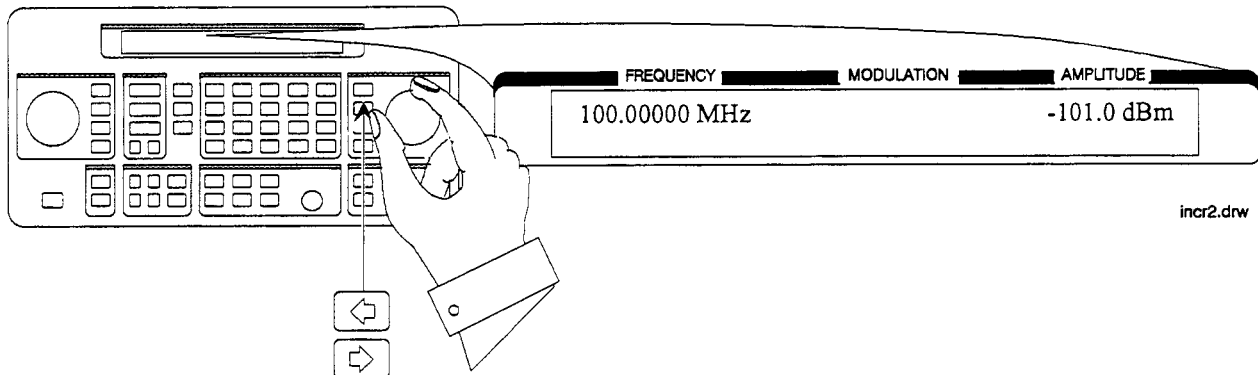

### Using the Increment keys

3. Enter a frequency increment of 25 kHz.

The  $\updownarrow$  symbol is displayed when you press **INCR SET** to indicate that the displayed value is the increment set value.

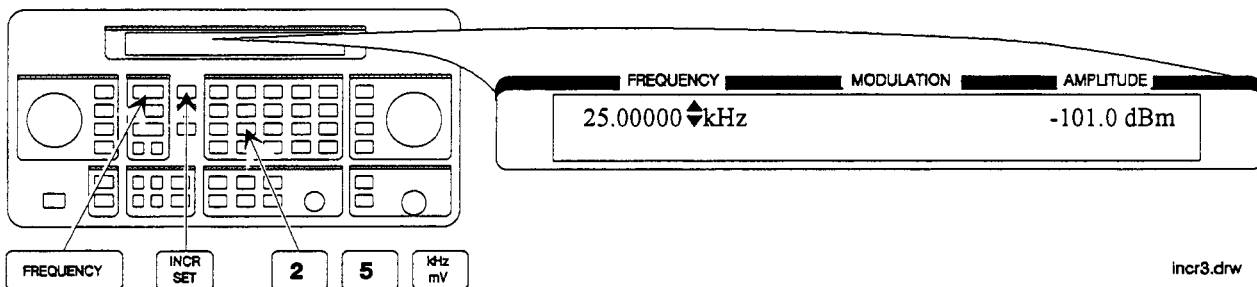

incr3.drw

4. Increment the RF output frequency in 25 kHz steps.

The increment keys affect the last FUNCTION selected (FREQUENCY, AMPLITUDE, FM, AM or  $\Phi$ M).

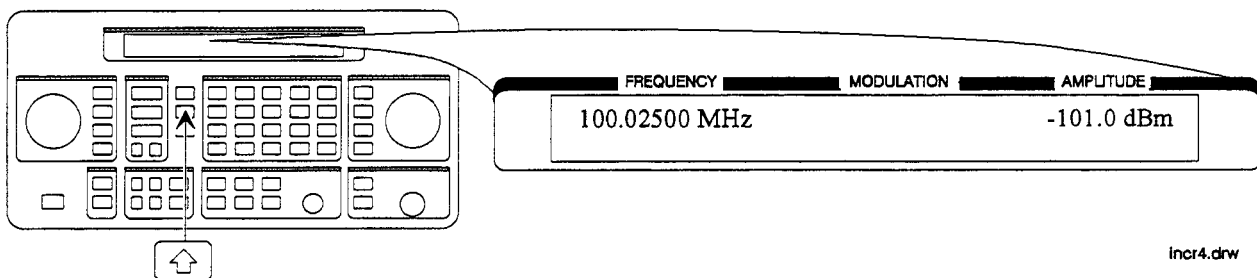

incr4.drw

## Using the Memory Registers

The memory register examples show you how to create a sequence of registers, delete a register from that sequence, renumber the registers in the sequence, and insert a new register in the sequence.

Up to 10 register sequences can be defined (0 through 9). A sequence can contain up to 100 registers (00 through 99). There are a total of 300 registers available in the instrument. The registers can be used in the sequences in any combination (such as 10 sequences of 30 registers each, or 3 sequences of 100 registers each) as long as the total does not exceed 300 registers. It is not possible to have all 10 sequences each contain 100 registers as that would be 1000 registers.

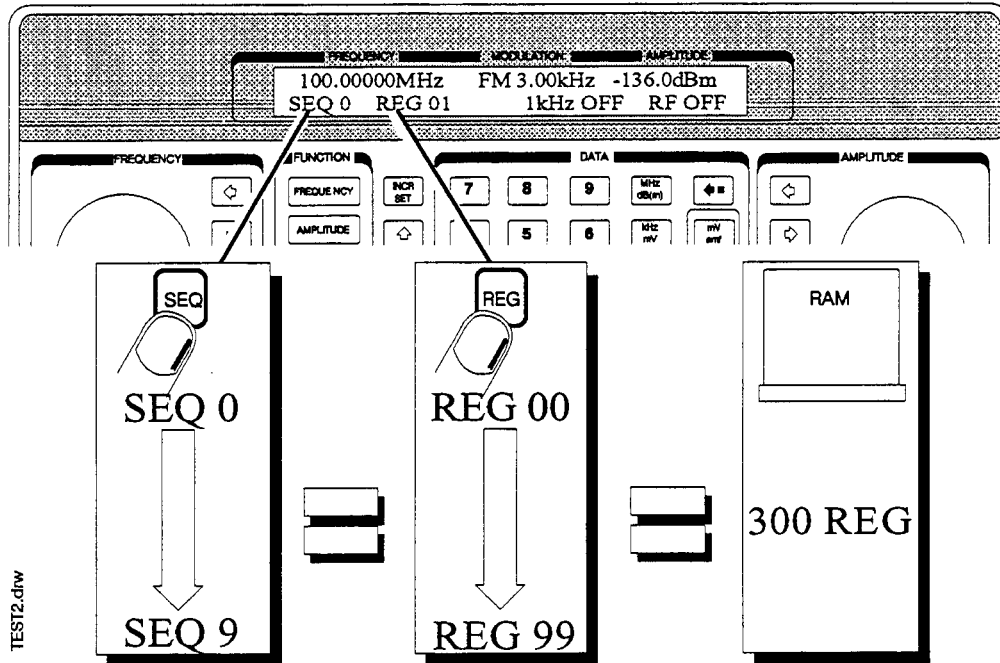



## Saving Instrument Settings in Register Sequences

In this ten step example, you will use the memory keys to create a sequence containing three registers. Each register will contain a different frequency setting.

### Selecting the Sequence

1. Select sequence 0.

If there are registers saved in sequence 0, the message shown in the display below will not appear. Note that the steps in this example will cause the settings in registers 00, 01, and 02 of sequence 0 to be changed.

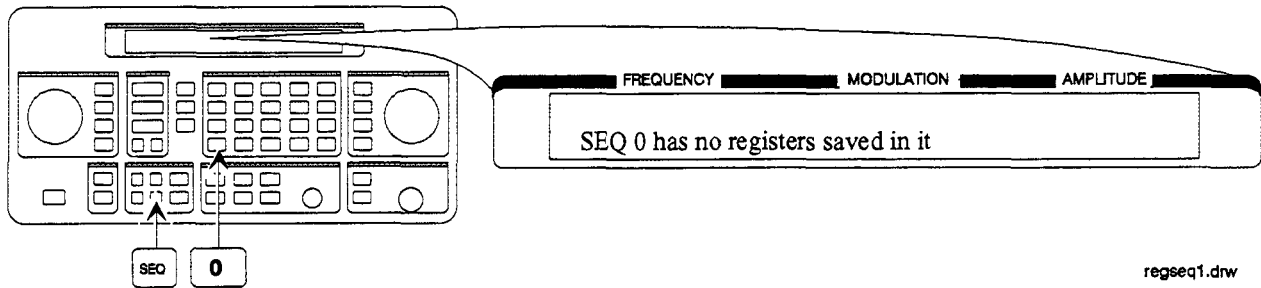

### Saving Settings in Registers

2. Set the frequency to 10 MHz.

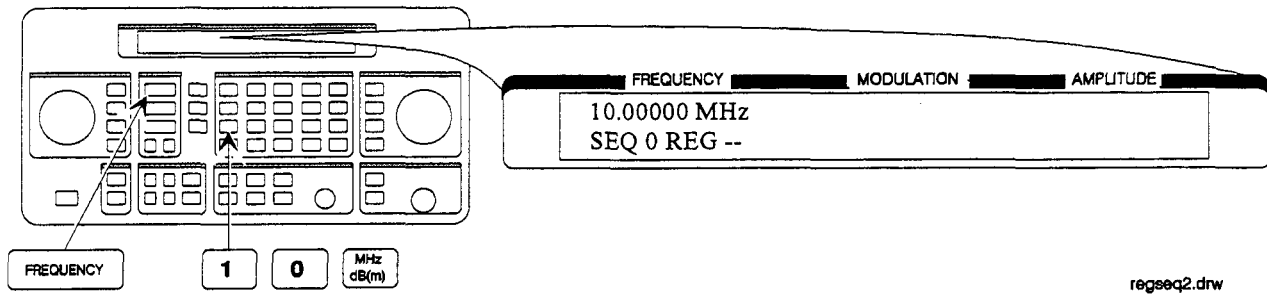

3. Save the instrument settings in register 00.

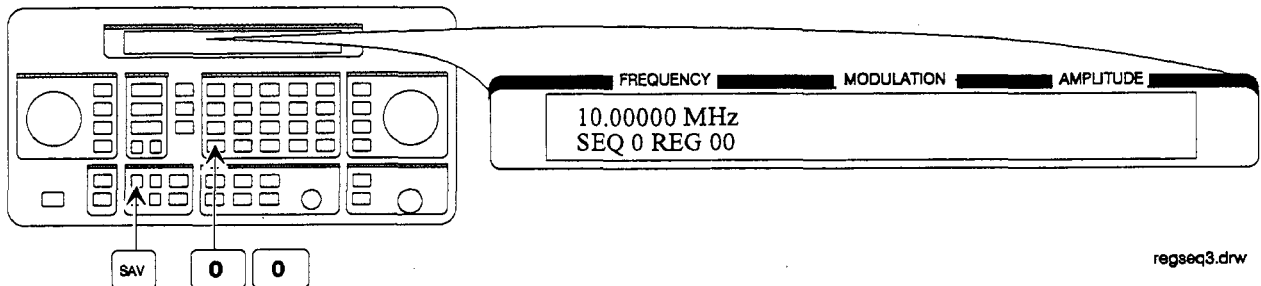

4. Set the frequency setting to 11 MHz.

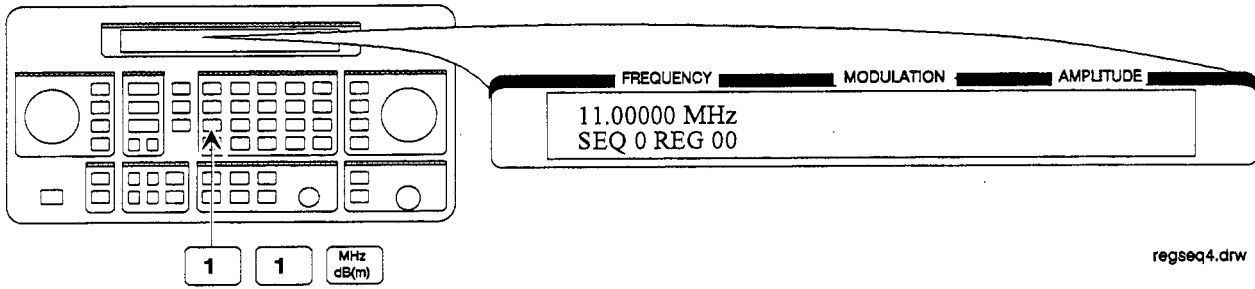

regseq4.drw

5. Save the instrument settings in register 01.

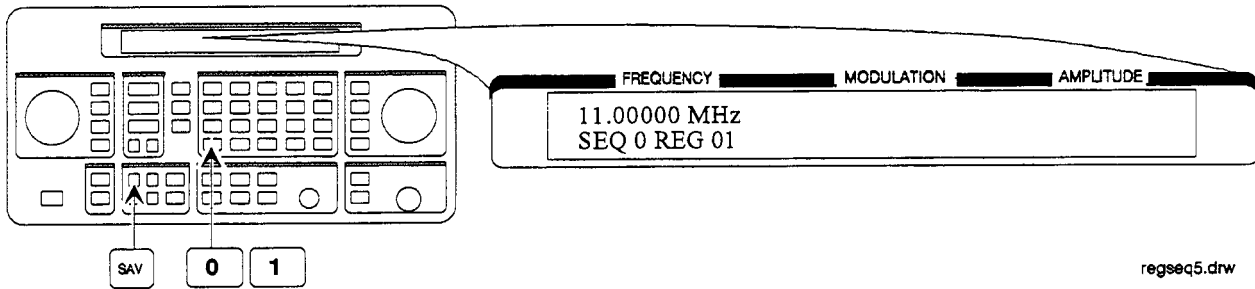

regseq5.drw

6. Set the frequency to 12 MHz.

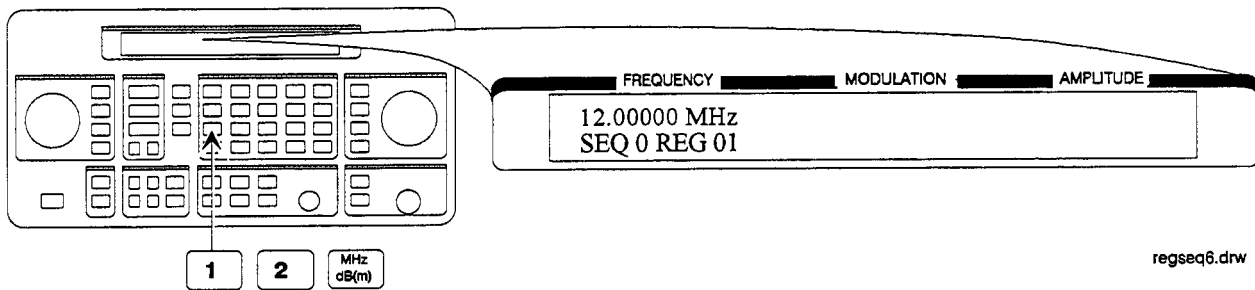

regseq6.drw

7. Save the instrument settings in register 02.

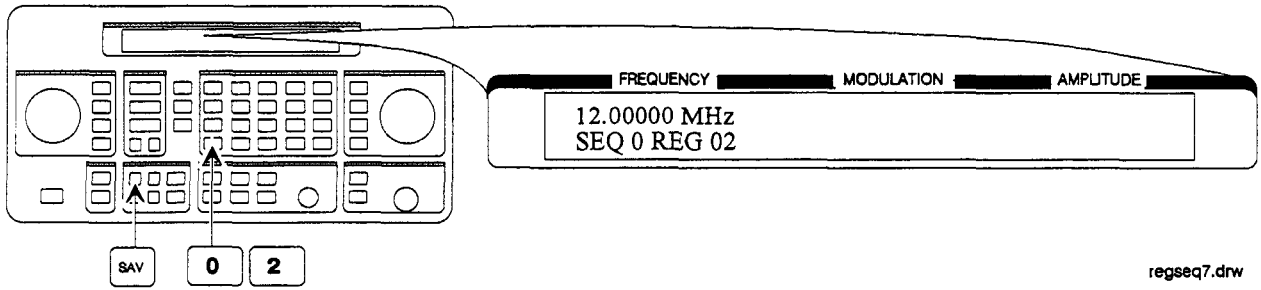

### Checking the Sequence

8. Recall the registers in sequence 0.

The  $\uparrow$  and  $\downarrow$  keys recall registers or sequences depending on which key was pressed last (**REG** or **SEQ**).

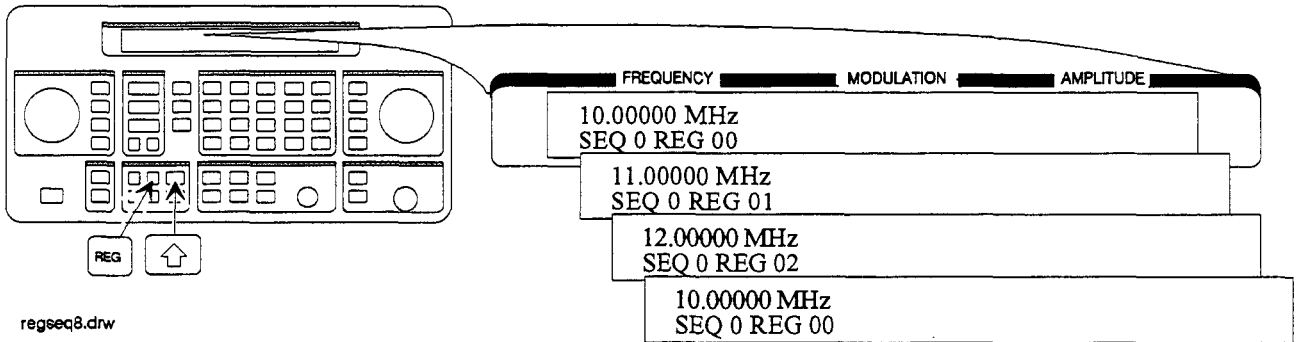

### Checking a Different Sequence

9. Select sequence 1.

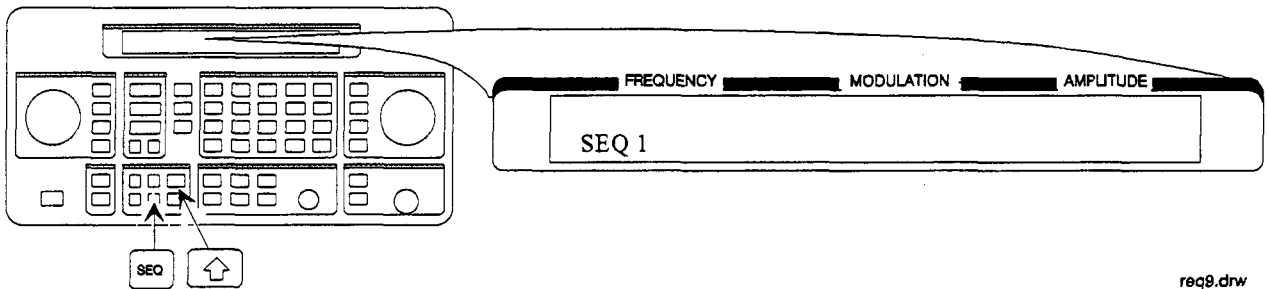

- Step through the registers in sequence 1 if there are registers saved in it.

**Note**

Sequence 1 does not contain the settings you saved in sequence 0. The instrument enables you to save different settings in each sequence to create up to ten different sequences for your testing. Remember when you save or recall a register, be sure that the correct sequence is also selected.

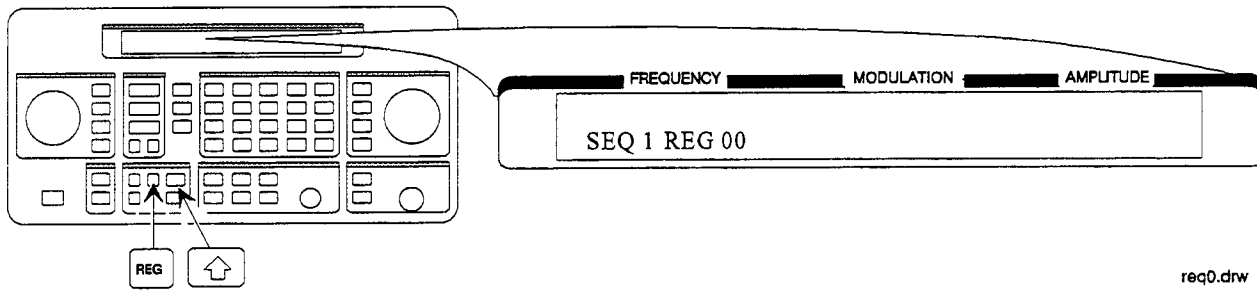

## Deleting a Register from the Sequence

In this example, you will delete a register from the sequence you created in the preceding example.

### Selecting the Sequence

1. Select sequence 0.

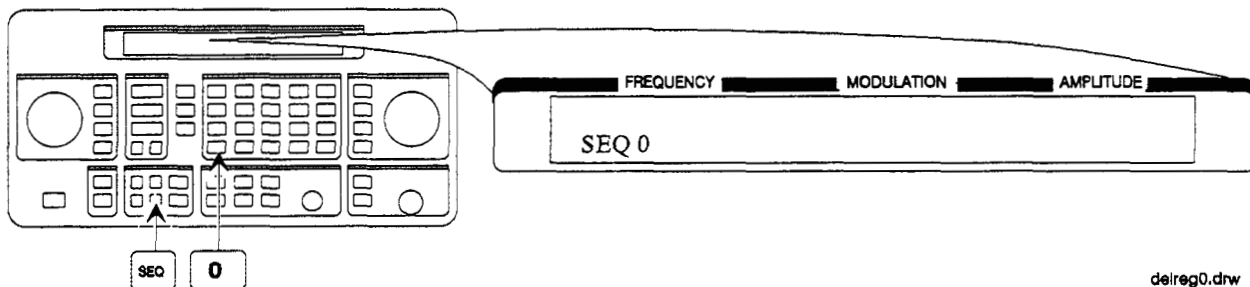

### Deleting a Register

2. Delete register 01 from sequence 0.

### Note

The contents of the register are recalled when it is deleted. This allows you to resave the contents if you need to.

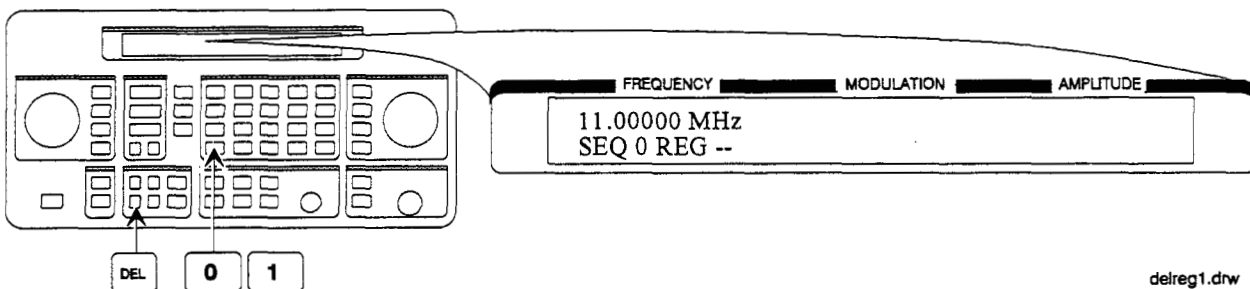

3. Step through the remaining registers in sequence 0.

The deleted register number has been removed from the sequence. Note that the instrument does not renumber the registers when one is deleted.

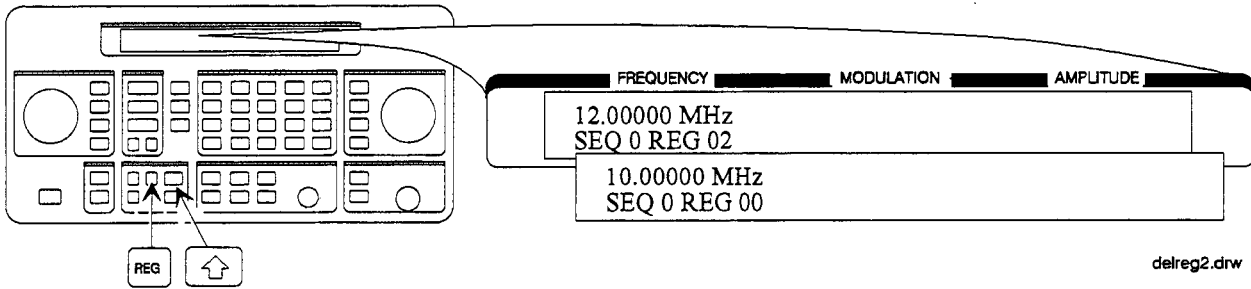

## Renumbering the Registers in a Sequence

In this example, you will eliminate the skip from register 00 to register 02 in sequence 0 caused when you deleted register 01 in the previous example.

### Decreasing the Register Number

1. Delete register 02.

The settings saved in register 02 are recalled when it is deleted.

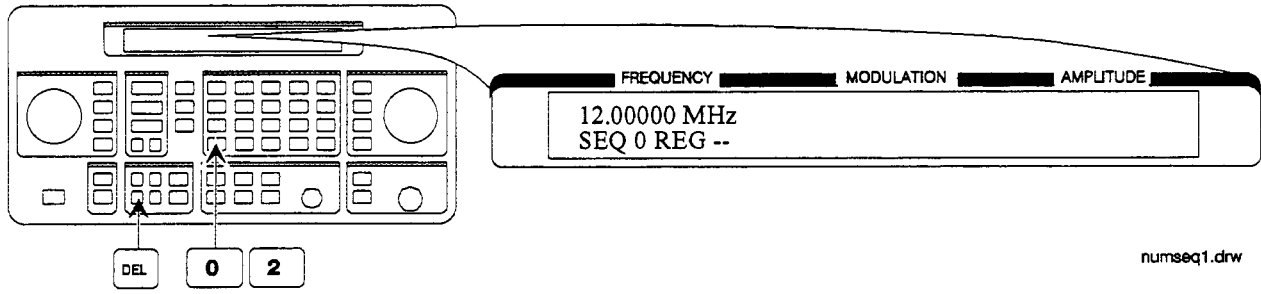

2. Save the settings from register 02 into register 01.

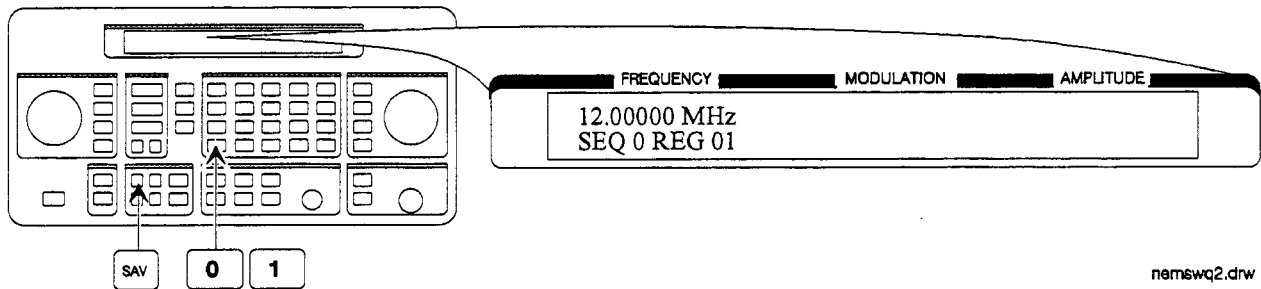

## Checking the Sequence

3. Step through the register sequence.

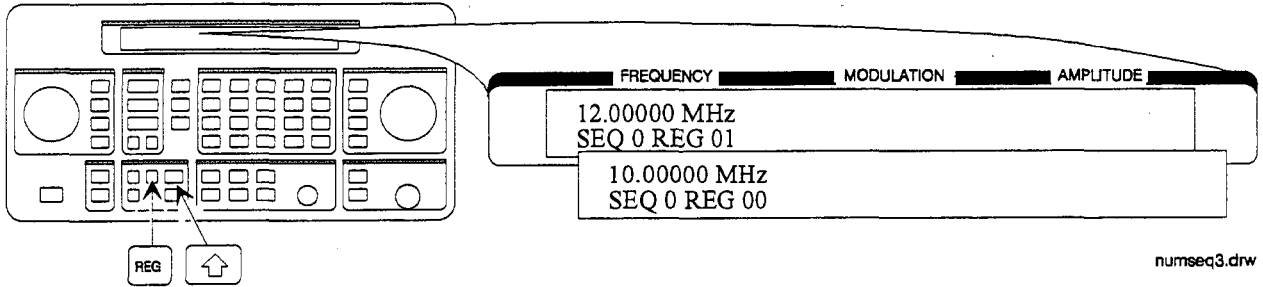

### Note

In this example, you renumbered one register. When you need to renumber two or more registers, use **REG** instead of **DEL** to recall each register until you get to the last register in the sequence, then use **DEL**.



## Inserting a Register in a Sequence

In this example, you will insert a register into the sequence you created in the previous example. The process involves incrementing each register number that comes after the point in the sequence where you wish to insert a register.

1. Recall the last register in sequence 0.

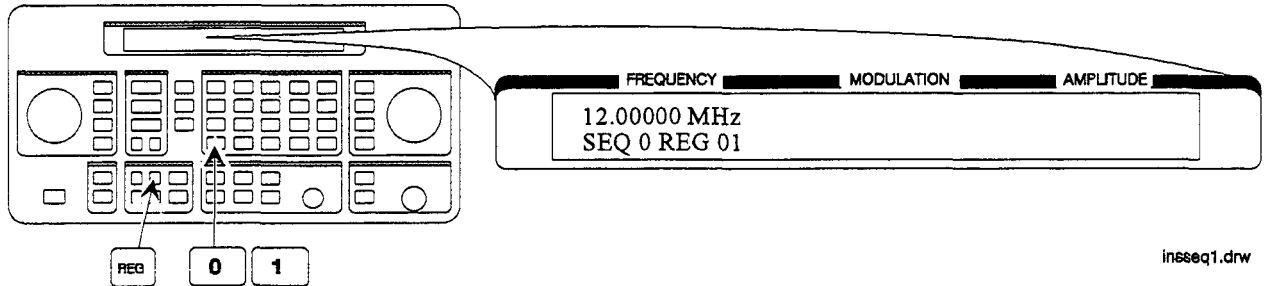

2. Save the recalled settings into register 02.

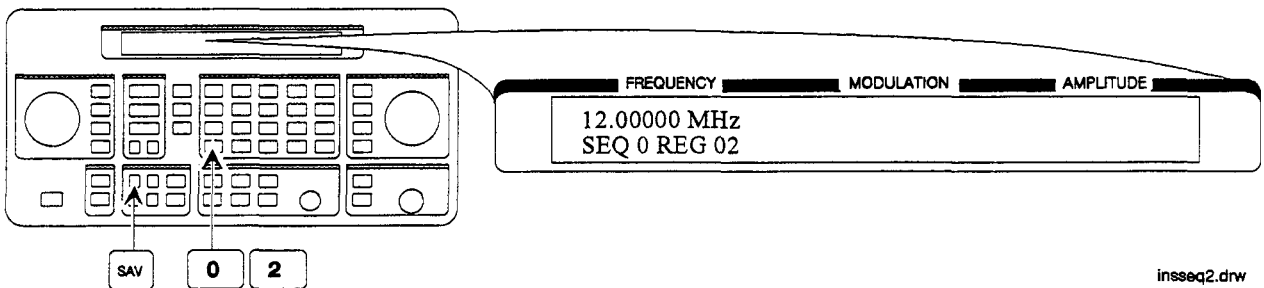

3. Recall register 00.

Register 01 can now be used to save the settings that are saved in register 00.

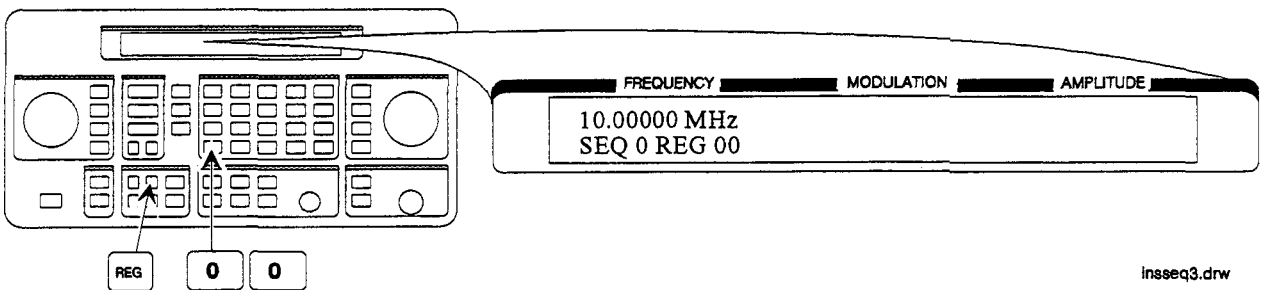

4. Save the recalled settings into register 01.

Register 00 can now be used to save the new settings.

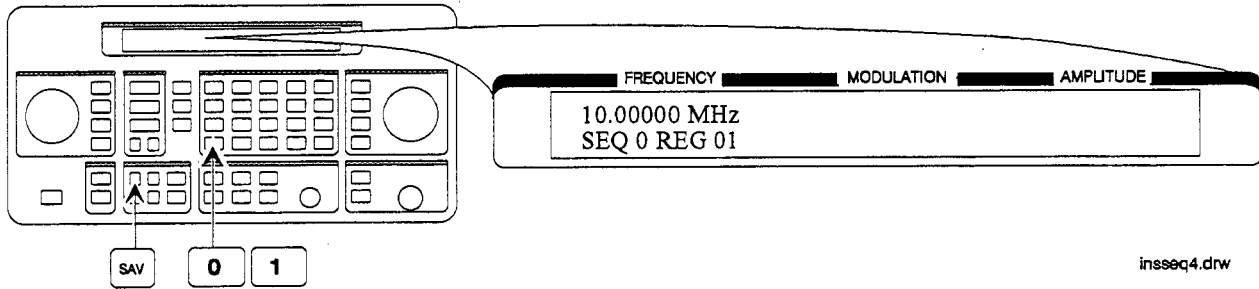

### Saving a New Register

5. Set the frequency to 8 MHz.

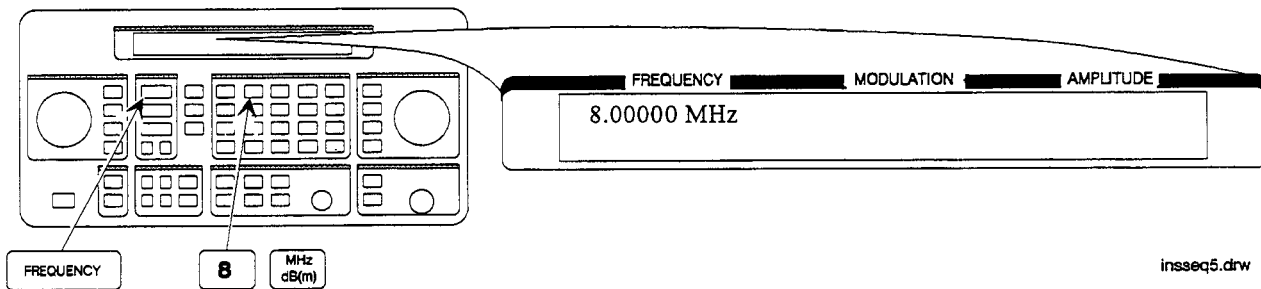

6. Save the settings in register 00.

Press  to check the new sequence.

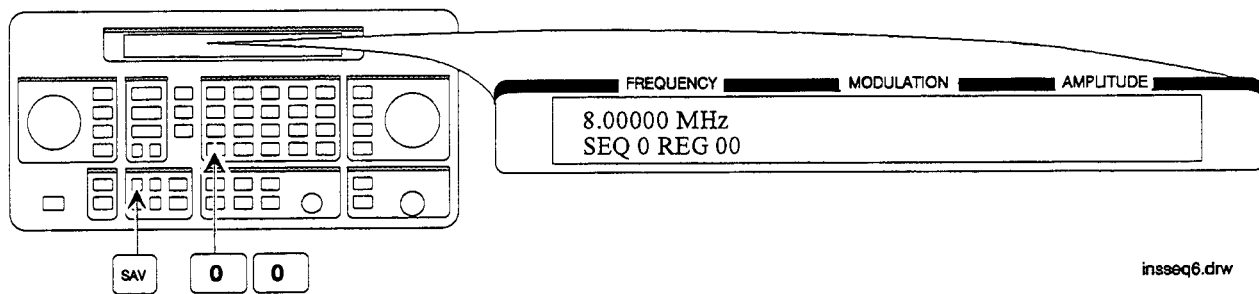

# Offsetting the RF Output from a Reference

In this example, you will enter an RF output frequency, set it as the reference value, and then offset the RF output frequency 10 MHz below the reference value.

## Setting the Reference Value

1. Set the frequency to 500 MHz.

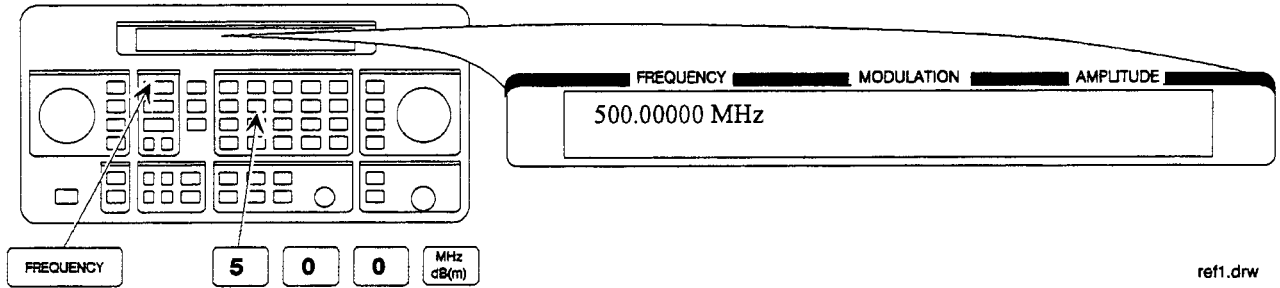

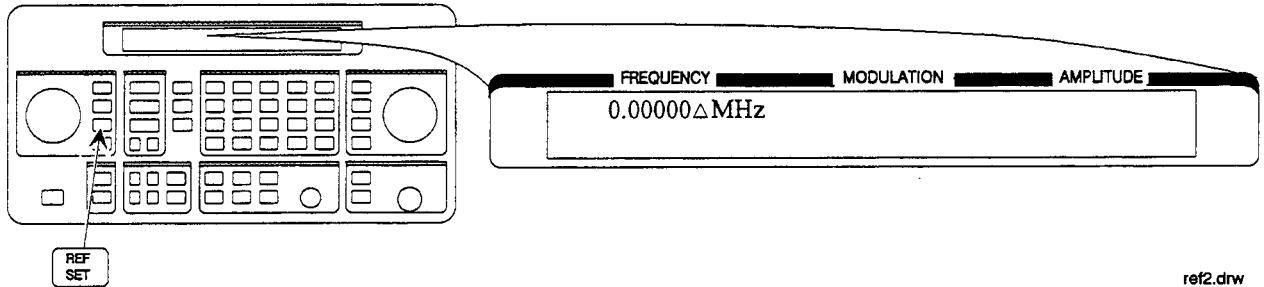

2. Set 500 MHz as the reference frequency.

The  $\Delta$  symbol appears in the display to indicate that the reference mode is selected. The output frequency is still 500 MHz.



## Offsetting the RF Output

3. Offset the output frequency 10 MHz below the reference frequency.

You can enter in the offset value directly, or use the knob or  and  keys.

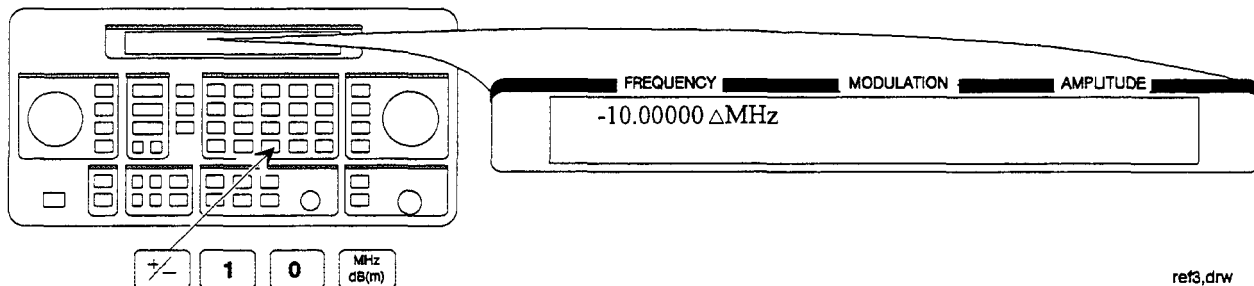

### Attention!

In the reference mode, the output frequency equals the reference frequency  $\pm$  the displayed offset frequency.

## Turning the Reference Mode Off or On

4. Turn-off the reference mode to display the actual output frequency.

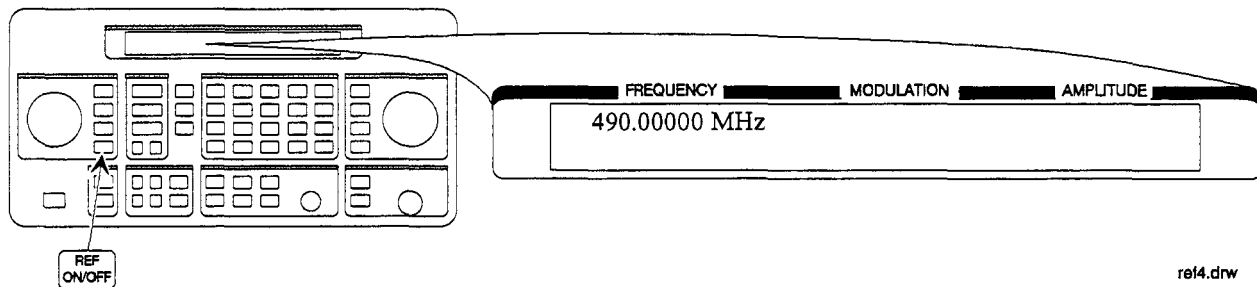

5. Turn-on the reference mode without changing the reference frequency.

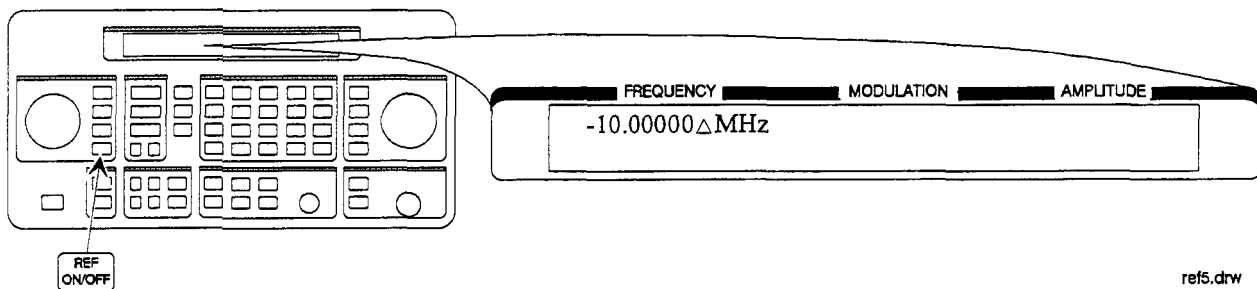

6. Change the displayed units to kHz.

Note that for amplitude, reference settings are displayed in dB units only.

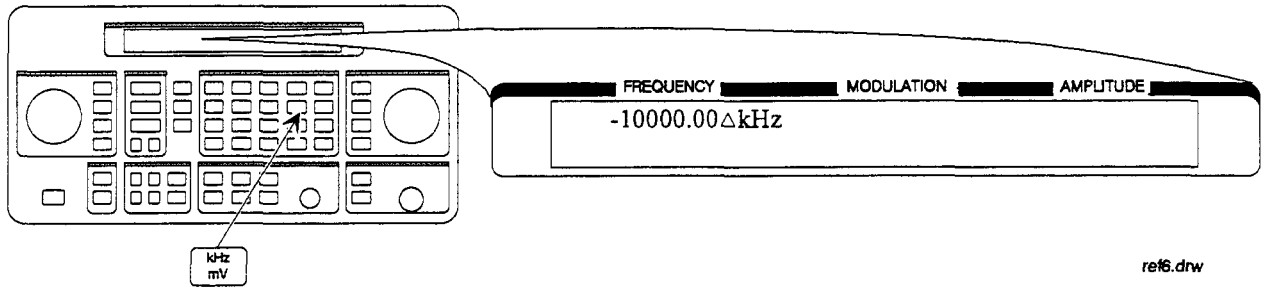

### Setting a New Reference Value

7. Set the current output frequency as the new reference frequency at any time.

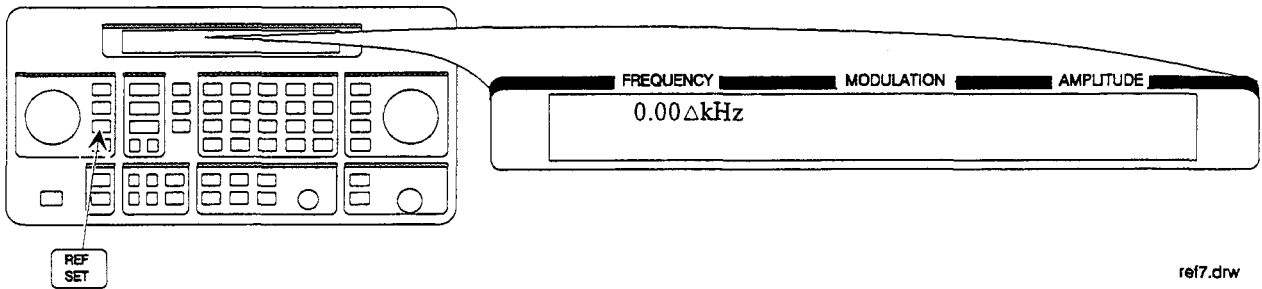

## Holding the Output Attenuator Range

In this example, you will hold the output attenuator so it does not change ranges when you change the amplitude setting. This will prevent attenuator range changes from affecting the output signal.

### Set the Amplitude Level

1. Set the amplitude level to  $-82$  dBm.

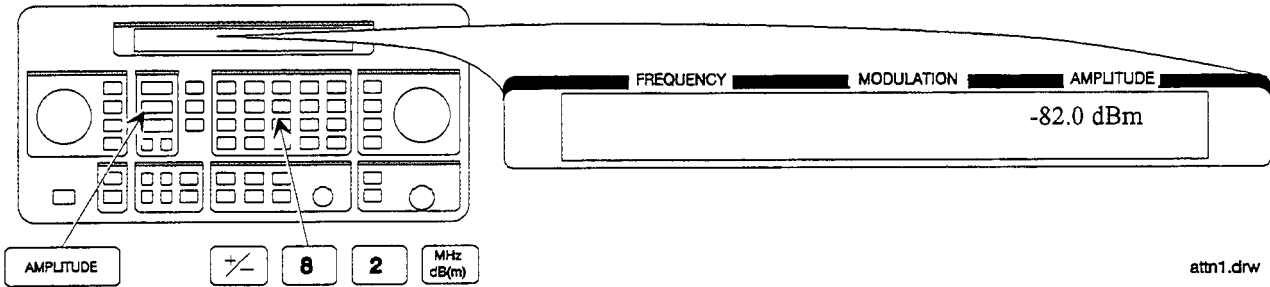

### Holding the Attenuator

2. Hold the attenuator at this setting.

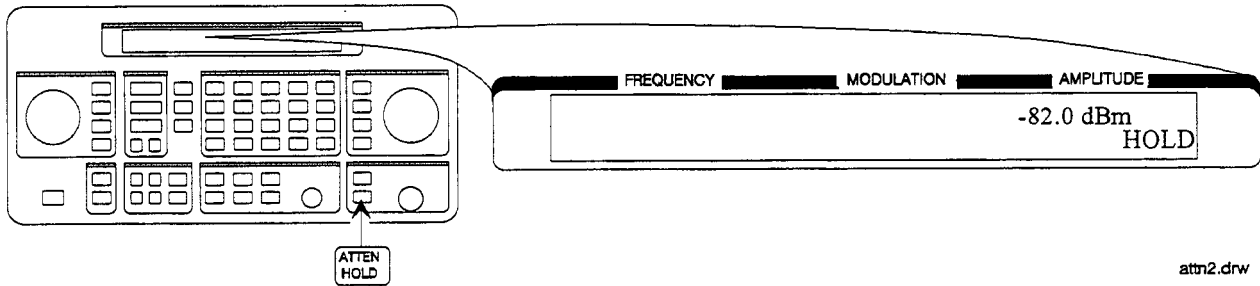

## Adjusting the Amplitude

### 3. Adjust the amplitude setting.

Now amplitude changes do not cause the attenuator to change its range setting. Consequently, amplitude changes are limited to the range provided by the instrument's vernier. For information about the instrument's vernier ranges, refer to Chapter 1b, "Operation Reference."

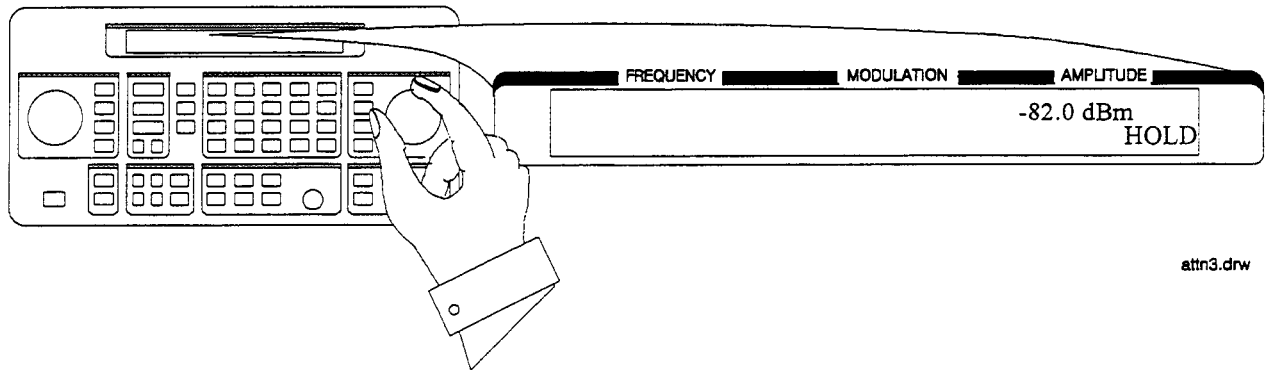

## **Operation Reference**

---

This chapter describes each of the instrument's functions including all of the front panel keys, the rear panel connectors, and the optional remote interface and memory interface. This information is presented in the same functional groups as the front panel key functional groupings.



## Frequency and Amplitude

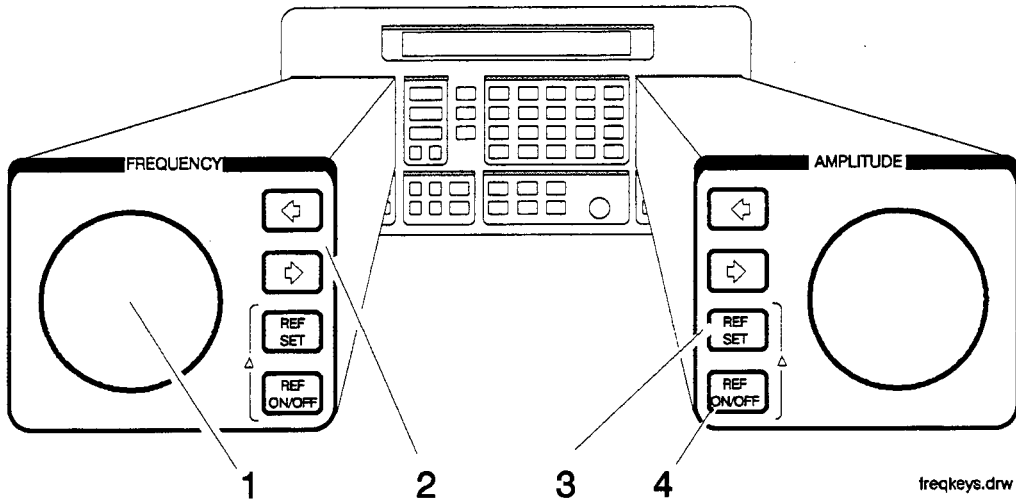

The knob and reference set keys work similarly for both frequency and amplitude.

**1. Knob**

Turn the knobs to increment or decrement the frequency and amplitude settings. The knobs are always active when the instrument is in local operation.

**2. Digit-Select Arrow Keys**

Press these digit-select arrow keys ( $\leftarrow$   $\rightarrow$ ) to select the digit to be changed with the knob.

**Note**

---

The knobs increment the selected digit only. For information about incrementing by an arbitrary value using the increment set keys, see “Increment Set” in this chapter.

---

**3. REF SET**

Press **REF SET** to turn on the reference mode and to set the current RF output setting as the reference value. The reference value is stored in non-volatile memory until you replace it by pressing **REF SET** again.

When you press **REF SET**, the  $\Delta$  symbol is displayed between the value and the units. When  $\Delta$  appears, the displayed value indicates the offset between the reference value and the RF output signal.

The RF output signal is not changed when you press this key.

**Units**

When you press **REF SET** for frequency, values can be entered in MHz or kHz. For amplitude, values can be entered in any of the amplitude units provided, but they are displayed in dB only.

**4. REF ON/OFF**

Press **REF ON/OFF** to turn off the reference mode if it is on, or to turn on the reference mode without changing the reference value.

When you turn on the reference mode, the displayed value indicates the offset between the reference value and the current RF output setting.

The RF output signal is not changed when you press this key.

**Output Power  
Trouble?**

---

If the RF output power seems too low, look for  $\Delta$  in the display between the power level value and the dB indicator. The  $\Delta$  tells you that reference mode is turned on. The displayed value is *not* the output power level; it is the offset between the reference value and the output power. To exit the reference mode, press **REF ON/OFF**. You can then reset the output power to the desired level.

---

## Function

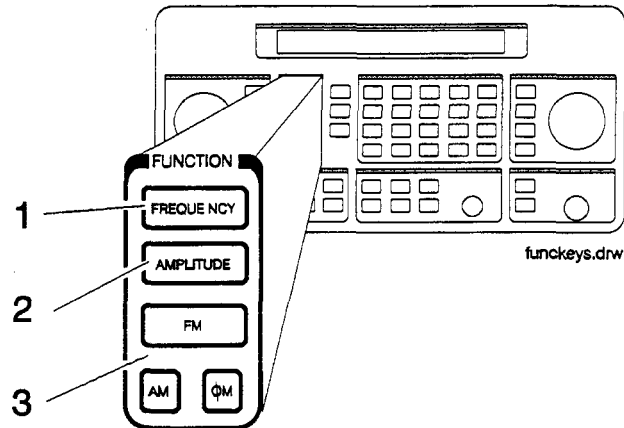

### 1. FREQUENCY

The RF output frequency range is 250 kHz to 1000 MHz. When making frequency changes, the instrument does not turn off the RF output.

Frequency switching typically takes less than 120 ms. Worst case conditions occur for changes which cross the instrument's two frequency band edges (249 MHz and 501 MHz).

### 2. AMPLITUDE

The RF output amplitude range is  $-136$  dBm to  $+10$  dBm with over-range to  $+13$  dBm. When making amplitude changes, the instrument does not turn off the RF output. The electronic attenuator provides rapid amplitude changes. The period of any over- or under-ranging that may occur during level transitions is typically less than 30 ms.

### 3. FM AM $\phi$ M

Press **FM** to set the peak deviation for frequency modulation. Then use the data entry keys to enter the desired value of deviation. The values allowed depend on the RF frequency selected. See Chapter 4, "Specifications" for peak deviation specifications.

Press **AM** to set the amplitude modulation range. Then use the data entry keys to set the desired value of range. Values from 0 through 100% are allowed.

Press  **$\phi$ M** to set the peak deviation for phase modulation. Then use the data entry keys to enter the desired value of deviation. The values allowed depend on the RF frequency selected. See Chapter 4, "Specifications" for peak deviation specifications.

# INCREMENT SET

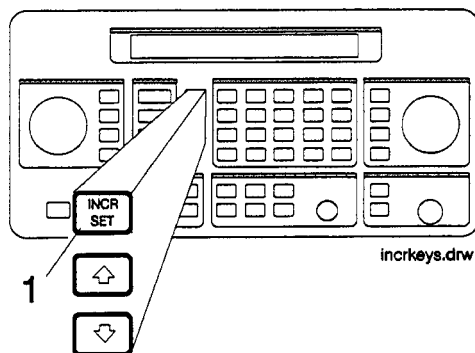

## 1. INCR SET

Press **INCR SET** to view or change the increment set value for the currently active function (the active function is the last function key you press; **FREQUENCY**, **AMPLITUDE**, **FM**, **AM**, or **φM**). When you press **INCR SET**,  $\updownarrow$  is displayed between the value and the units. The  $\updownarrow$  indicates that the displayed value is the increment set value.

### Note

An increment value cannot be set for the knobs or the memory recall arrow keys.

### Increment Set Ranges

Function	Range
Frequency	1 Hz to 999.75 MHz
Amplitude	> 0.0 to 149.0 dB
FM Deviation	> 0.0 to 100 kHz
AM Depth	> 0.0 to 100%
φM Deviation	>0.0 to 10.0 Radians

### Note

It is possible to set an increment value of greater resolution than can be displayed or than the hardware can respond to. However, the instrument records each arrow key press and will respond after the appropriate number of presses.

## Data

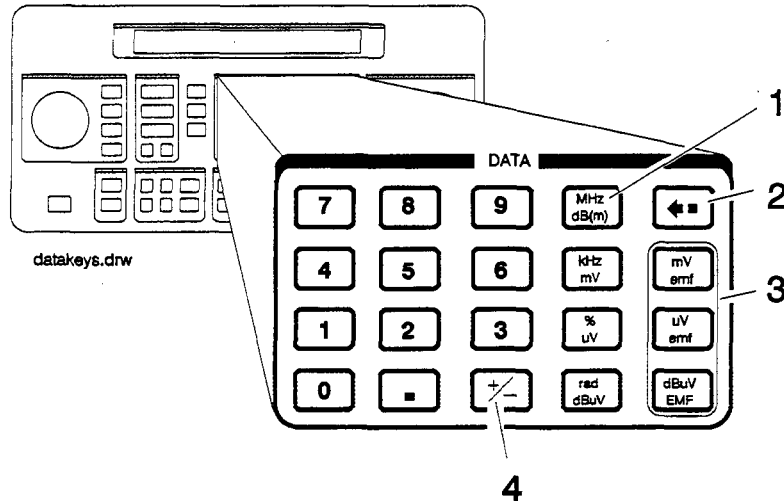

- 1. MHz/dBm** Press a units key after you enter a value. This terminates the entry. Note that the units keys in the left column are each labeled with an amplitude unit on the bottom and a frequency or modulation unit on the top. The instrument applies the appropriate unit for the function value you are entering. The bottom key in the row for instance, terminates a  $\phi M$  entry in radians or an amplitude entry in  $dB\mu V$ .

**Note** Memory register selections, sequence selections, and HP-IB address entries do not require a units key to terminate the entry. These entries are automatically terminated after the last digit is entered.

### Units Conversion

You can change the units of the displayed frequency or amplitude value by selecting the FUNCTION (frequency or amplitude) and then pressing a units key. The instrument will convert the displayed value to the equivalent value for the units key you pressed.

- 2. Backspace** Press  $\leftarrow$  when entering a numeric value to backspace and remove the last digit entered.
- 3. emf** Press these keys to display the amplitude value indicated on the key label in electromotive force units. Emf is the RF output voltage with no load. It is twice the output voltage with a 50 ohm load.
- 4.  $\pm$**  Press this key at any time while you are entering an amplitude or reference offset value to change the sign of the value.

---

## Instrument Preset

**POWER** **←**

Turn the instrument on while pressing the backspace key (**←**) to perform an instrument preset. The instrument will power up to factory-defined settings shown in the following table. Save and recall registers are not affected by this operation.

**POWER** **DEL**

Turn the instrument on while pressing the memory (**DEL**) key to perform a clear memory. This function erases all save/recall registers, sets the HP-IB address to 19, and performs an instrument preset where the instrument powers up to factory-defined settings shown in the following table.

---

### Note

This will cause an error message to appear on the display:  
627 Battery RAM failure: memory lost. This is normal.

---

Instrument Preset Settings

Function	Parameter	Setting
RF Frequency	Frequency	100 MHz
	Increment	10 MHz
	Reference	0.0 MHz
RF Amplitude	Power Level	-136 dBm
	Increment	1.0 dBm
	Reference	0.0 dBm
FM	Input	Internal
	Frequency	1 kHz
	Coupling	AC
	State	Off
	Deviation	3.0 kHz
	Increment	0.1 kHz
AM	Input	Internal
	Frequency	1 kHz
	State	Off
	Depth	30%
	Increment	0.1%
$\phi$ M	Input	Internal
	Frequency	1 kHz
	Coupling	AC
	State	Off
	Deviation	1.0 radians
	Increment	0.1 radians
RF	State	Off
Attenuator	Coupling	Off

## HP-IB

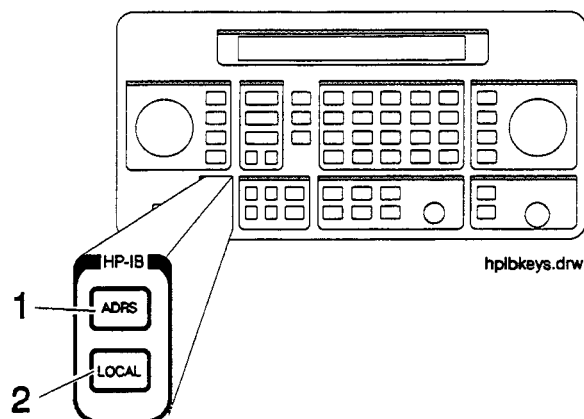

- 1. ADRS** Press **ADRS** to view the instrument's HP-IB address setting in the second line of the FREQUENCY display.  
To change the address, press **ADRS** and a two-digit number. For example, enter 01 to set the address to 1.  
Acceptable HP-IB addresses are 00 through 30.
  
- 2. LOCAL** Press **LOCAL** to return to front-panel operation when the instrument has been set for remote (HP-IB) operation. The SEQ and REG fields will replace the HP-IB status indications in the second line of the FREQUENCY display when the instrument is returned to local operation.



## MEMORY

The memory keys allow you to save instrument settings into memory registers and recall the registers in a numeric sequence.

Up to 10 register sequences can be defined (0 through 9). A sequence can contain up to 100 registers (00 through 99). There are a total of 300 registers available in the instrument. The registers can be used in the sequences in any combination (such as 10 sequences of 30 registers each, or 3 sequences of 100 registers each) as long as the total does not exceed 300 registers. It is not possible to have all 10 sequences each contain 100 registers as that would be 1000 registers.

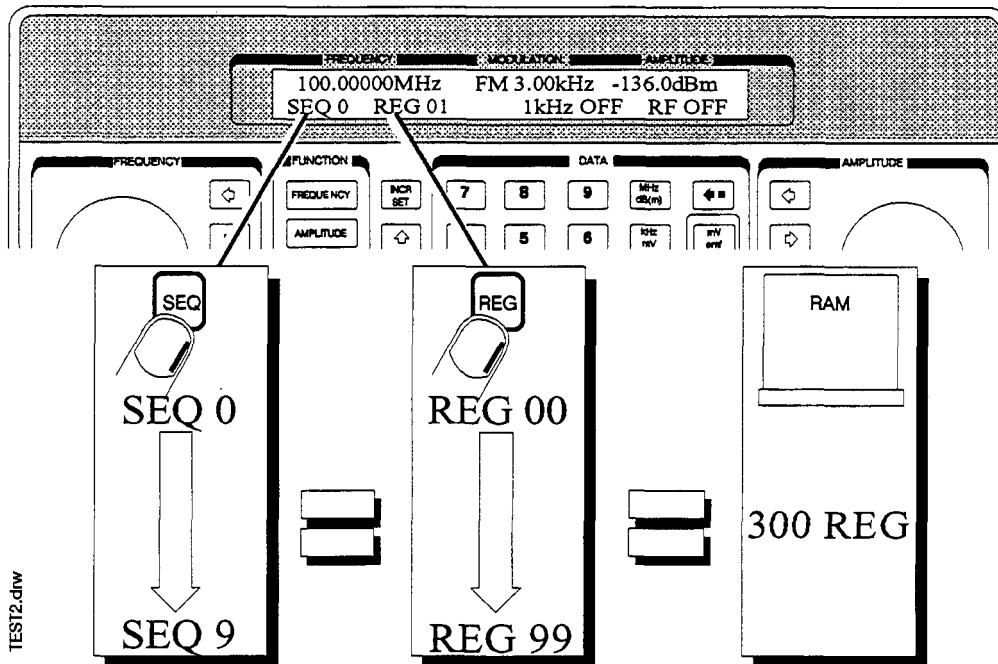

MEMORY key entries are automatically terminated after you enter the last digit. Register key entries ( **SAV**, **DEL**, and **REG** ), require two digits. Sequence key entries ( **SEQ** ) require one digit.

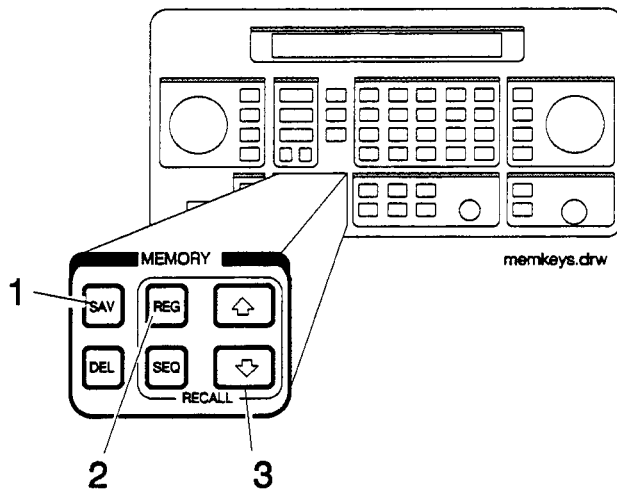

- 1. SAV** Press **SAV** and a register number (00 through 99) to save the current operating settings in a memory register. All front-panel settings except the knob digit positions and the HP-IB address will be saved in the register.

When you press the **SAV** key, a message is displayed to tell you the total number of registers still available.

When you save a register, it is assigned to the currently selected sequence. (The number of the selected sequence appears in the second line of the FREQUENCY display.) You can only recall a register when the sequence it is assigned to is selected.

(Refer to "4. SEQ" for further information about register sequences.)

---

**Note**

The instrument does not have a copy function for saving registers from one sequence to another.

---

## Memory

**2. REG** Press **REG** and a register number (00 through 99) to recall the operating settings saved in that register.

The number of the last register recalled appears in the display along with the number of the currently selected sequence.

You can only recall registers from the currently selected sequence.

To recall a register from another sequence you must first select the sequence using the **SEQ** key.

### **3. Register Recall Arrows**

The recall **↑** and **↓** keys can be used to select sequences or recall registers. The last key pressed (SEQ or REG) determines which field is affected by the arrow keys.

(Refer to "4. SEQ" for further information about register sequences.)

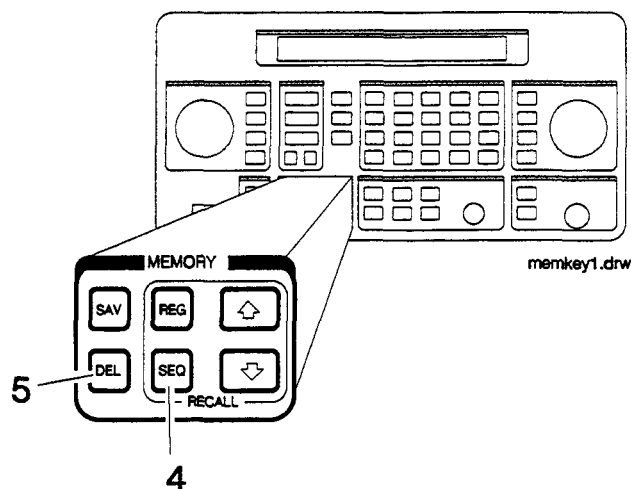

- 4. SEQ** Press **SEQ** and a sequence number (0 through 9) to select a register sequence. When you select a sequence, the number of the sequence appears in the display along with the number of the first register saved in the sequence. The instrument is set to the operating settings saved in the first register. If no registers have been saved in the sequence, a message is displayed to let you know.

---

**Note** Selecting the sequence you are currently in is a quick way to return to the beginning of the sequence.

---

A sequence can include up to 100 registers (00 through 99). (There are a total of 300 registers available in the instrument.) Registers are automatically assigned to the currently selected sequence when they are saved.

The registers saved in any given sequence are independent from the registers in any other sequence. This allows you to create up to 10 different register sequences. Consequently, it is possible to have up to ten registers with the same number (for example, REG 01) each assigned to a different sequence and each with different operating settings saved in it.

## Memory

- 5. DEL** Press **DEL** and a register number (00 through 99) to delete that register. The specified register is deleted from the currently selected sequence only; registers in other sequences you have set up are not affected. After you have deleted a register, you will not be able to recall that register number until you have saved operating settings in it again.

---

### Note

The register number is immediately deleted from the sequence when the delete entry is completed. However, the settings contained in the register are recalled when you delete the register so you can re-save the settings if you need to.

---

### Renumbering the Registers

If you use the arrow keys to recall the registers in sequence, the deleted register number will be skipped. If you wish to eliminate the skip, you can do so by moving each register following the deleted register back one register number. To delete an entire sequence, delete each register in the sequence.

# Modulation Source

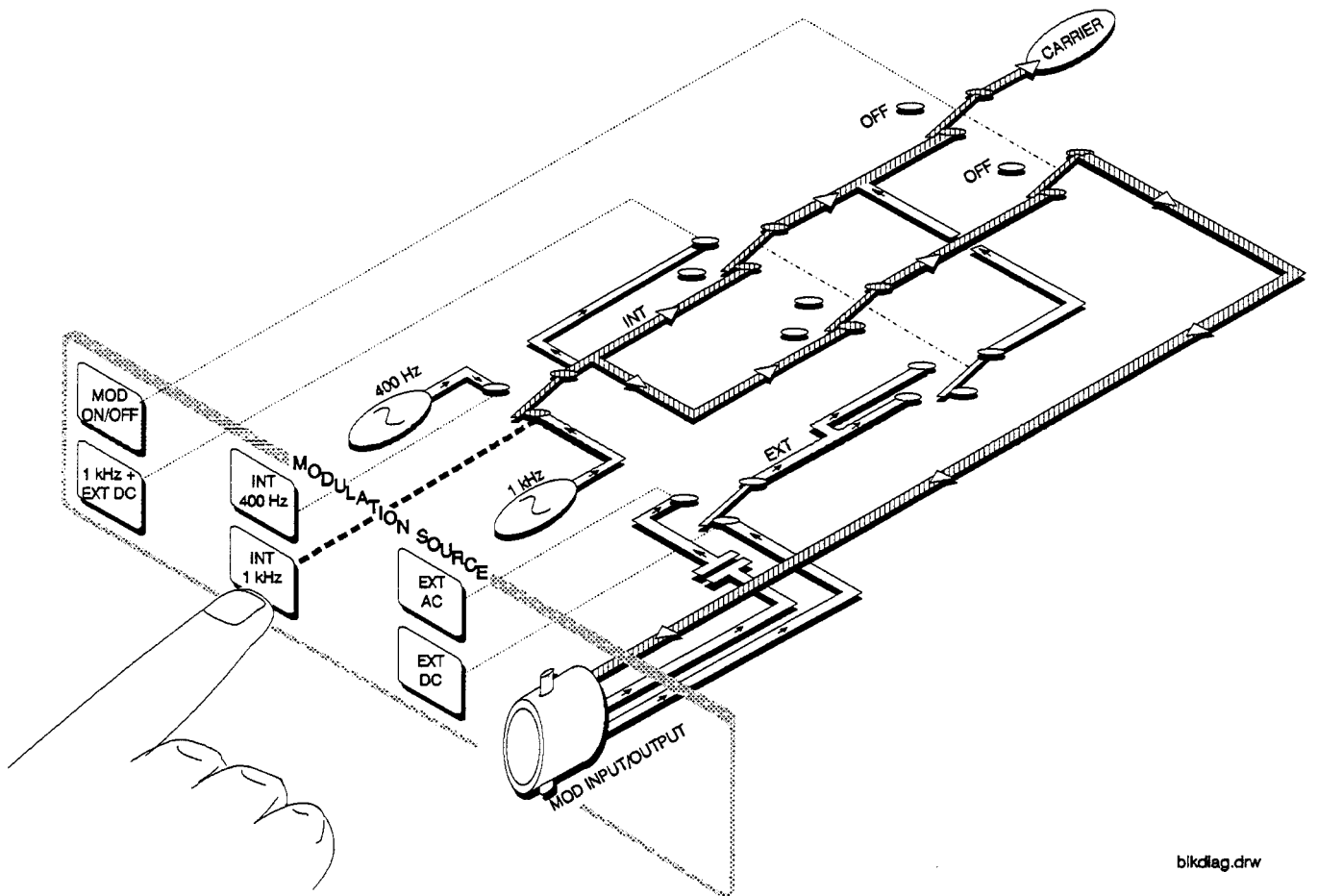

bkdlag.drw

Modulation Source Paths (the 1 kHz path is highlighted)

## Modulation Source

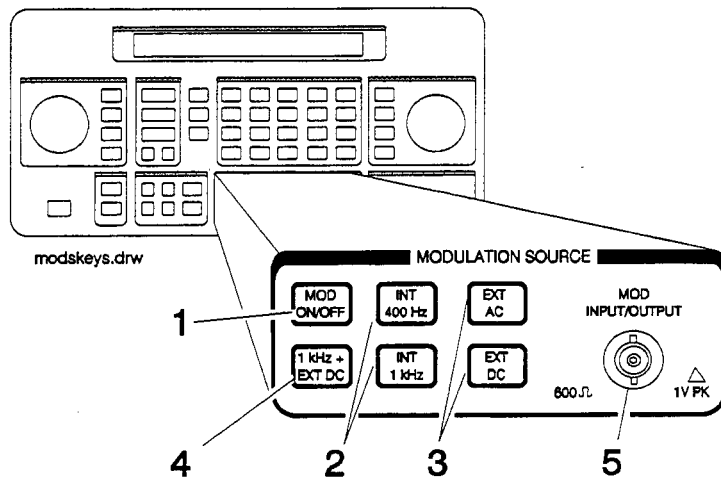

### 1. MOD ON/OFF

Press **MOD ON/OFF** to turn on or off the currently-selected modulation mode (AM, FM, or  $\phi$ M). OFF appears in the second line of the MODULATION display when modulation is turned off.

This key also turns on or off the audio output at the MOD INPUT/OUTPUT connector when an internal source (400 Hz or 1 kHz) is selected. The operation of this key is the same as the **MOD ON/OFF** key on the HP 83300A Remote Interface.

### 2. INT 400 Hz INT 1 kHz

Press one of these keys to select an internal source for modulating the carrier. The selected source is also output at the MOD INPUT/OUTPUT port as a 1 Vpk signal into 600 $\Omega$ .

### 3. EXT AC EXT DC

Press one of these keys to configure the MOD INPUT/OUTPUT port as an ac- or dc-coupled input for modulating the carrier.

Calibrated modulation requires an audio source of 1 Vpk into 600 $\Omega$ . For audio source frequencies of less than 10 kHz, a HI or LO indicator will appear in the second line of the MODULATION display when the level of the source is not within approximately  $\pm 5\%$  of 1 Vpk.

#### Acceptable Frequency Ranges for an External Audio Source

Modulation	Coupling	Range
FM, $\phi$ M	EXT AC	20 Hz to 75 kHz
	EXT DC	DC to 75 kHz
AM	EXT AC	20 Hz to 25 kHz
	EXT DC	

**4. 1 kHz + EXT DC**

Press **1 kHz + EXT DC** to configure the MOD INPUT/OUTPUT port as a DC coupled input for modulating the carrier along with the internal 1 kHz source.

(Refer also to “3. EXT AC EXT DC” for further information about operation and acceptable ranges.)

**Note**

1 kHz + EXT AC, 400 Hz + EXT DC, and 400 Hz + EXT AC are available only via HP-IB.

**Setting the Modulation Level**

When modulating with both an internal and external source, the level of the external source should not exceed 0.5 V peak or 0.5 Vdc. This level will provide one half of the displayed modulation. To set modulation to the level you desire, set the displayed modulation to two-thirds of the desired setting. The external source, set to 0.5 V peak or 0.5 Vdc, will provide the additional one-third of the desired setting (one-half of the instrument's setting).

For example, to set up the modulation for 3 kHz of FM deviation, set the instrument for 2 kHz of FM. The external source, set to 0.5 V peak, will provide another 1 kHz of deviation.

If the external source is set to less than 0.5 V peak, the modulation level provided by the source will be less than one-half of the displayed resolution. The following equation may be helpful for determining the appropriate modulation level setting for the instrument when the level of the external source is less than 0.5 V.

$$\frac{A}{1 + E} = D$$

Where:

A = Actual modulation level

E = External source level

D = Displayed modulation level

For example, to set up for 3 kHz of FM deviation with an external source set to 0.3 V peak, the instrument's displayed modulation level would be:

$$\frac{3kHz}{1 + 0.3V} = 2.3kHz$$

**5. MOD INPUT/OUTPUT**

This port outputs a 1 Vpk (into 600Ω) audio tone when an internal modulation source is selected (400 Hz or 1 kHz). When external coupling is selected (**EXT AC**, **EXT DC** or **1 kHz + EXT DC**), it provides the input for a 1 Vpk (into 600Ω) audio source. (Refer to the preceding table for acceptable audio ranges.)



## RF OUTPUT

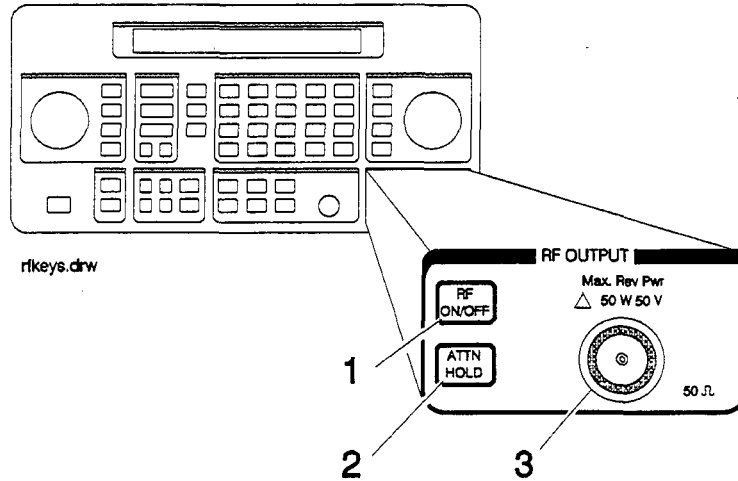

- 1. RF ON/OFF** Press **RF ON/OFF** to turn the RF output signal on or off. RF OFF appears in the second line of the AMPLITUDE display when the output signal is off.

The instrument turns off the output signal by switching in the maximum output attenuation (130 dB) and setting the vernier to its lowest setting. This results in approximately 170 dB of carrier isolation.

- 2. ATTN HOLD** Press **ATTN HOLD** to hold the electronic step attenuator at its current setting. HOLD appears in the second line of the AMPLITUDE display when the attenuator hold function is on.

When the attenuator hold function is on, amplitude adjustments are limited to the range of the instrument's vernier. The vernier provides 0.1 dB per step adjustment resolution across its specified 10 dB range.

### Vernier Ranges

The following table (10 dB Specified Vernier Ranges) provides the upper and lower limits of each vernier range. The instrument's amplitude setting when you press the **ATTN HOLD** key determines which vernier range is used.

The vernier is allowed to over-range and under-range beyond the limits shown in the table when **ATTN HOLD** is selected. However, amplitude settings that exceed the limits may not provide output levels that are within the accuracy specifications of the instrument.

## 10 dB Specified Vernier Ranges

Range	Upper and Lower Limits
1	+ 10.0 dBm to -5.9 dBm
2	-6.0 dBm to -15.9 dBm
3	-16.0 dBm to -25.9 dBm
4	-26.0 dBm to -35.9 dBm
5	-36.0 dBm to -45.9 dBm
6	-46.0 dBm to -55.9 dBm
7	-56.0 dBm to -65.9 dBm
8	-66.0 dBm to -75.9 dBm
9	-76.0 dBm to -85.9 dBm
10	-86.0 dBm to -95.9 dBm
11	-96.0 dBm to -105.9 dBm
12	-106.0 dBm to -115.9 dBm
13	-116.0 dBm to -125.9 dBm
14	-126.0 dBm to -136.0 dBm

**3. RF OUTPUT**

The RF output port is reverse-power protected to 50 W or 25 Vdc into 50 $\Omega$ . When the instrument senses a reverse-power signal, it turns the RF output off, the step-attenuator to maximum attenuation, and the vernier to its lowest setting. A message appears in the second line of the display when the reverse-power protection has been activated.

After you have removed the reverse-power signal from the RF output, press the **RF ON/OFF** key to turn the output signal on again.

**Caution**

---

Applying a signal source exceeding 50 W or 25 Vdc into 50 $\Omega$  to the RF output port or maintaining a signal source at the RF output for an extended period of time may damage the instrument.

---

### Rear Panel

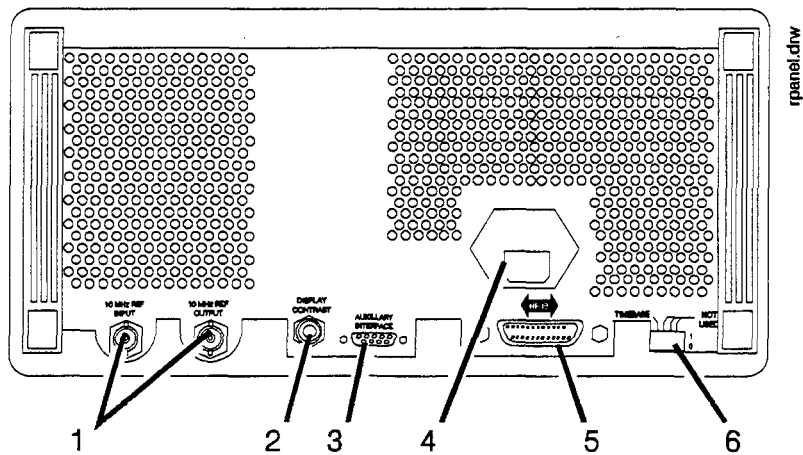

#### 1. 10 MHz REF INPUT and OUTPUT

These connectors provide the input and output ports for the instrument's timebase reference. The instrument will lock to a 2 MHz, 5 MHz, or 10 MHz external reference source connected to the input that is within  $\pm 5$  ppm. When the internal timebase is being used, the output connector provides a 10 MHz, 1 Vrms level signal.

#### 2. DISPLAY CONTRAST

This knob controls the front-panel display contrast. Display contrast can be optimized for viewing the display from above, below, or directly in front of it.

### 3. AUXILIARY INTERFACE

Connect the HP 83300A Remote Interface or the HP 83301A Memory Interface to this connector for operation with the instrument. Refer to "Remote Interface" and "Memory Interface" in this section for information about operating these devices.

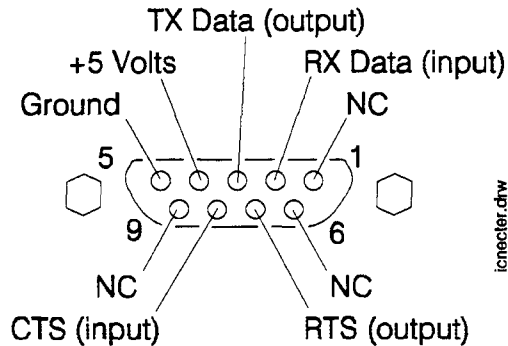

### 4. Line Voltage Connector

For information about the line voltage connector or fuse replacement, refer to Chapter 3, "Installation."

### 5. HP-IB Connector

This is an IEEE 488.1-1987 connector for controlling the instrument via an external controller. For information about HP-IB operation of the instrument, refer to Chapter 2, "HP-IB Programming."

### 6. TIMEBASE ADJUST and Help Switches

Position one of this switch (labeled "TIMEBASE ADJUST") places the instrument in the timebase adjustment mode. For the timebase adjustment procedure, refer to Chapter 7, "Adjustments."

Position two of this switch (labeled "NOT USED") is the switch which allows you to turn off the following error messages:

001	No external dc coupling for PM
002	Modulation exceeds deviation range
004	Invalid units selection
005	Increment value entry out of range
006	End of increment range
007	Entered value out of range
008	Amplitude exceeds specified range
010	End of knob range
011	Amplitude exceeds ATTN HOLD limits
012	No external dc coupling for AM
013	AM unspecified above 4 dBm
014	AM unspecified at or below 1.5 MHz

For more information about these messages, refer to Chapter 1c, "Operation Messages."

## Remote Interface (Accessory)

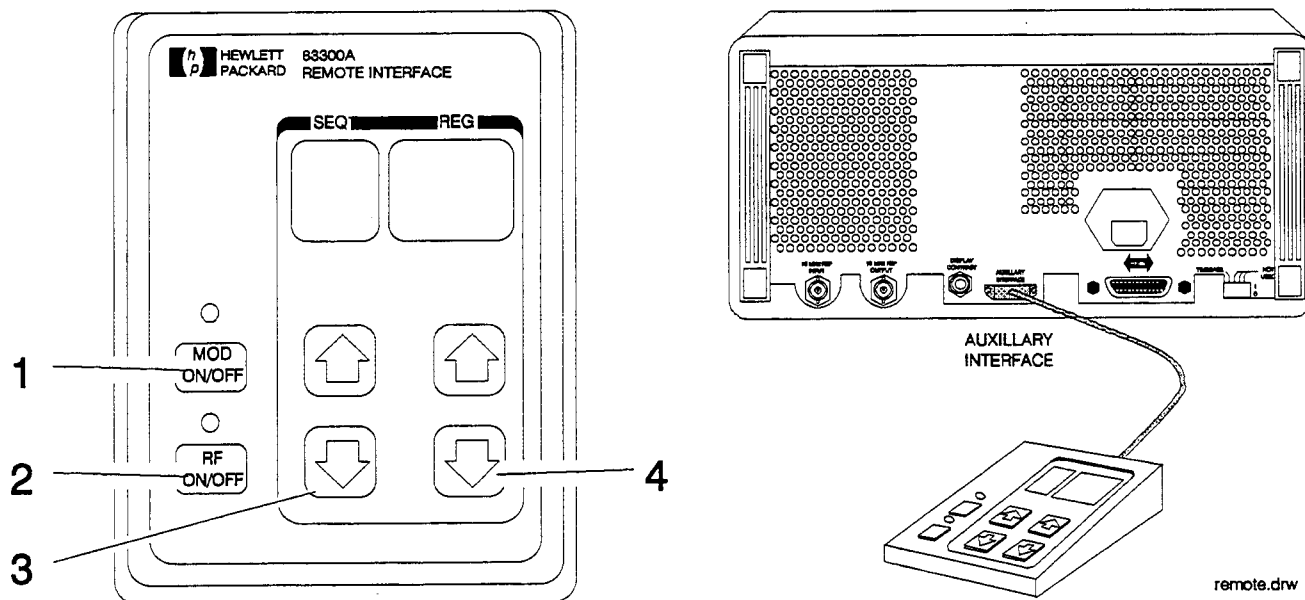

### 1. MOD ON/OFF

Press **MOD ON/OFF** to turn on or off all modulation (internal and external) to the RF carrier. When modulation is turned off, the LED above the key is off and OFF appears in the second line of the instrument's MODULATION display.

This key also turns on or off the audio output at the MOD INPUT/OUTPUT port when an internal source (400 Hz or INT 1 kHz) is selected.

### 2. RF ON/OFF

Press **RF ON/OFF** to turn the RF output signal on or off. When the RF output signal is turned off, the LED above the key is off and RF OFF appears in the second line of the instrument's AMPLITUDE display. There is approximately 170 dB of carrier isolation when the output is off.

### 3. Sequence Selection Arrows

Press  $\uparrow$  or  $\downarrow$  to select the next or previous sequence of registers. The sequences are selected in numeric order. The number of the selected sequence appears in the second line of the FREQUENCY display. When a sequence is selected, the first register in the sequence is recalled. When a sequence is selected that has no registers saved in it, two dashes (- -) will appear in the REG field.

### 4. Register Recall Arrows

Press  $\uparrow$  or  $\downarrow$  to recall the operating settings saved in the registers in the currently selected sequence. The number of the last register accessed appears in the REG field.

If two dashes (- -) appear in the REG field, a sequence that has no registers saved in it has been selected.

After the last register in the sequence has been recalled, the register count will begin again at the first register saved in the sequence.

(Refer to "MEMORY" in this section for further information about register sequences.)

## Memory Interface (Accessory)

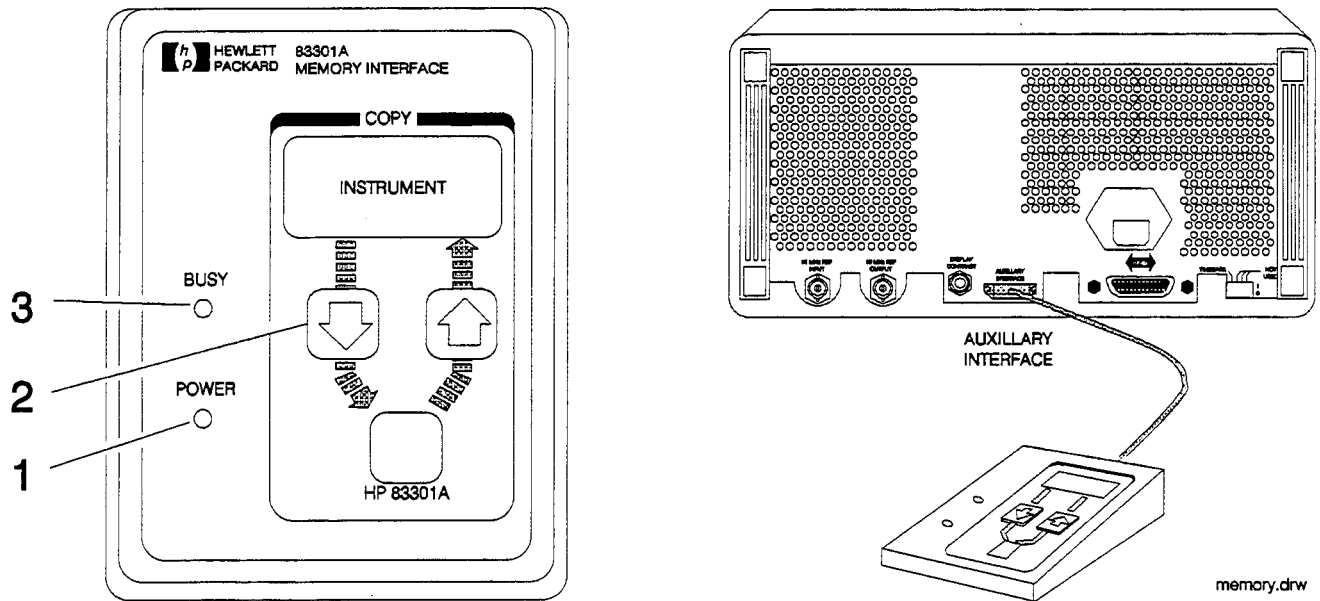



- 1. POWER** This light indicates that power is being supplied to the HP 83301A. It should light when the cable is connected to the AUXILLARY INTERFACE connector on the rear panel of the instrument. If it does not light, refer to Chapter 5b, "Troubleshooting Information."

## 2. Copy Arrow Keys

Press these keys to initiate a copy of the memory registers between the instrument and the HP 83301A. After the instrument has successfully completed the copy, it will display a message to let you know.

### Making a Copy

When the HP 83301A is connected to the instrument, press the  to copy all of the memory registers saved in the instrument into the HP 83301A's memory. After you have pressed an arrow key, you must also press the  key on the instrument's front panel to begin the copy process. Press the  to copy the memory registers stored in the HP 83301A into the instrument's memory.

---

### Note

Copying memory into the instrument or the HP 83301A causes any existing memory registers in the receiving device to be erased. It does not effect the memory in the sending device, however.

---

## 3. BUSY

This light is turned on while memory registers are being copied from one device to another. Attempting to operate the instrument or memory interface while this light is on may cause the memory data to be corrupted. The light will turn off when the copy is complete.

If the Busy light flashes for a few seconds and then turns off, the instrument did not find valid memory register data in the memory interface. If the Busy light continues to flash, or if it does not turn on at all after an arrow key and the  key have been pressed, refer to Chapter 5b, "Troubleshooting Information."



## Operation Messages

---

This chapter provides descriptions for both front panel and HP-IB operation messages. (For information about service messages, numbered 500 and above, refer to Chapter 5c, "Service Error Messages.")

---

### Front Panel Operation Messages

SEQ X SAVE \_ \_ XXX registers available

This message is displayed when the **(SAV)** key is pressed to inform you of how many registers are still available. If a register is available, enter the two-digit number of the register you wish to save.

SEQ X REG \_ \_ XX has not been saved

This message is displayed when an attempt is made to recall a register that has not been saved in the sequence. Check to be sure that the appropriate sequence is selected and that you have entered the correct register number.

SEQ X DEL \_ \_ Enter number to delete

This message is displayed when the **(DEL)** key is pressed. Enter the number of the memory register you wish to delete. When a register is deleted, the settings saved in it are erased and the register number is removed from the sequence.

SEQ X has no registers saved in it

This message is displayed when a sequence is selected that has no registers saved in it. If you wish to save registers in the sequence, set-up the instrument, press the **(SAV)** key, and enter a two-digit register number.

001 No external dc coupling for PM

This message is displayed when PM is selected and **(EXT DC)** or **(1 kHz + EXT DC)** is also selected. DC coupling of an external source is not possible for PM. If you press **(1 kHz + EXT DC)** you will actually get 1 kHz and external *ac*. Or, select **(EXT AC)** coupling for PM. Additional internal plus external modulation capabilities (such as **(1 kHz + EXT AC)**) are available through HP-IB control of the instrument; refer to Chapter 2, "HP-IB Programming."

- 002      **Modulation exceeds deviation range**
- This message is displayed when modulation is set to a level that exceeds the operating range of the instrument. This condition occurs when a modulation level is entered that is out-of-range for the current RF frequency setting, or when the RF frequency setting is changed and the modulation setting is out-of-range for the new setting.
- 003      **There are no registers available**
- This message is displayed when an attempt is made to save a memory register and all of the instrument's memory registers have already been used. Delete any unneeded registers in order to save new ones. Deleting registers from any sequence will make them available for saving new settings in the sequence you are using.
- 004      **Invalid units selection**
- This message is displayed when a units key is pressed that is not valid for the active function. Check that the units key you select is labeled with the appropriate units for the value you are entering.
- 005      **Increment value entry out of range**
- This message is displayed when the **INCR SET** key is pressed and a value is entered that is not within the increment value range for the active function. Refer to "Increment Set" in Chapter 1b, "Operation Reference," for a listing of the increment value ranges.
- 006      **End of increment range**
- This message is displayed when the **↑** or **↓** increment arrow key is pressed and the increment value does not set the instrument to a setting that is within the instrument's allowable range. To view or change the increment value, press the **INCR SET** key. Refer to "Increment Set" in Chapter 1b, "Operation Reference," for a listing of the increment value ranges.
- 007      **Entered value out of range**
- This message is displayed when a value is entered that does not set the RF output signal within the instrument's allowable range. Refer to "Function" in Chapter 1b, "Operation Reference," for information on the instrument's allowable ranges.
- 008      **Amplitude exceeds specified range**
- This message is displayed when the instrument's amplitude is set to a level that exceeds +10 dBm.
- 010      **End of knob range**
- This message is displayed when the knob is turned but changing the selected digit would set the instrument to a value that is not within its allowable range.

- 011      **Amplitude exceeds ATTN HOLD limits**
- This message is displayed when **ATTN HOLD** is on and the amplitude is set to a level that exceeds the vernier range limits by greater than 5 dBm. Exceeding the 10 dB vernier range of an attenuator hold setting causes the output level accuracy to degrade. For information about the vernier ranges and limits, refer to "Atten Hold" in Chapter 1b, "Operation Reference."
- 012      **No external dc coupling for AM**
- This message is displayed when AM is selected and **EXT DC** or **1 kHz + EXT DC** is also selected. DC coupling of an external source is not possible for AM. If you press **1 kHz + EXT DC** you will actually get 1 kHz and external *ac*. Or, select **EXT AC** coupling for AM. Additional internal plus external modulation capabilities (such as 1 kHz + EXT AC) are available through HP-IB control of the instrument; refer to Chapter 2, "HP-IB Programming."
- 013      **AM unspecified above 4 dBm**
- This message is displayed when AM is selected and amplitude is set to greater than 4 dBm. To insure that AM will meet its specified performance, reduce the amplitude setting to 4 dBm or less.
- 014      **AM unspecified at or below 1.5 MHz**
- This is caused when AM is selected and RF frequency is set to 1.5 MHz or less. To insure that AM will meet its specified performance, increase the RF frequency setting.
- 015      **Help messages off**
- This message is displayed when the instrument is powered up and the rear panel help switch has been set to disable the following error messages: 001, 002, 004, 005, 006, 007, 008, 010, 011, 012, 013, 014. The second switch position (next to the timebase adjust, labeled "NOT USED") controls the display of these messages.
- 020      **Press **SAV** to copy memory FROM 8647/8**
- This message is displayed when the **⇩** key is pressed on an HP 83301A Memory Interface connected to the instrument. Press the **SAV** key to copy the memory registers saved in the instrument into the memory interface.
- 021      **Copying registers from 8647/8**
- This message is displayed while the memory registers are being copied from the instrument to the HP 83301A Memory Interface.
- 022      **Press **SAV** to copy memory TO 8647/8**
- This message is displayed when the **⇧** key is pressed on an HP 83301A Memory Interface connected to the instrument. Press the **SAV** key to copy memory registers that had been saved in the memory interface into the instrument.

- 023      **Copying registers to 8647/8**  
This message is displayed while the memory registers are being copied from the HP 83301A Memory Interface to the instrument.
- 024      **Invalid data in Memory Interface**  
This message is displayed when the instrument detects that the HP 83301A Memory Interface does not contain valid memory register data. Try copying a memory register into the memory interface first, then initiate a copy from the memory interface to the instrument again.
- 025      **Communication failure: copy aborted**  
This message is displayed when the instrument is not able to successfully copy memory registers between the instrument and the HP 83301A Memory Interface. This message will be displayed if the cable connecting the instrument to the primary interface is disconnected during the copy process.
- 026      **Memory copy was successful**  
This message is displayed when the instrument has successfully copied the memory registers between the instrument and the HP 83301A Memory Interface. When this message is displayed, the copy process is complete and you can disconnect the memory interface from the instrument.

---

## HP-IB - Command Errors

- 101 Invalid character  
A syntactic element contains a character which is invalid for that type; for example, a header containing an ampersand, SETUP&. This error might be used in place of errors -121, -141, and perhaps some others.
- 102 Syntax error  
An unrecognized command or data type was encountered. For example, a string was received when the **device** does not accept strings. Additional information is available over HP-IB.
- 103 Invalid separator  
The parser was expecting a separator and encountered an illegal character. For example, the semicolon was omitted after a program unit, \*EMC1:CH1:VOLTS5.
- 104 Data type error  
The parser recognized a data element different than one allowed. For example, numeric or string data was expected but block data was encountered.
- 105 GET not allowed  
A Group Execute Trigger was received within a program message (see *IEEE 488.2.7.7*).
- 108 Parameter not allowed  
More parameters were received than expected for the header. For example, the \*EMC common command only accepts one parameter, so receiving \*EMC0,1 is not allowed.
- 109 Missing parameter  
Fewer parameters were received than required for the header. For example, the \*EMC common command requires one parameter, so receiving \*EMC is not allowed.
- 111 Header separator error  
A character which is not a legal header separator was encountered while parsing the header. For example, no white space followed the header, thus \*GMC"MACRO" is in error.
- 112 Program mnemonic too long  
The header contains more than twelve characters (see *IEEE 488.2 7.6.1.4.1*).
- 113 Undefined header  
The header is syntactically correct, but it is undefined for this specific **device**. For example, \*XYZ is not defined for any **device**.

- 121 Invalid character in number  
An invalid character for the data type being parsed was encountered. For example, an alpha in a decimal numeric or a "9" in octal data.
- 123 Exponent too large  
The magnitude of the exponent was larger than 32000 (see *IEEE 488.2, 7.7.2.4.1*).
- 124 Too many digits  
The mantissa of a decimal numeric data element contained more than 255 digits excluding leader zeros (see *IEEE 488.2 7.7.2.4.1*).
- 128 Numeric data not allowed  
A legal numeric data element was received, but the **device** does not accept one in this position for the header.
- 131 Invalid suffix  
The suffix does not follow the syntax described in *IEEE 488.2 7.7.3.2*, or the suffix is inappropriate for this **device**.
- 134 Suffix too long  
The suffix contained more than 12 characters (see *IEEE 488.2, 7.7.3.4*).
- 141 Invalid character data  
Either the character data element contains an invalid character or the particular element received is not valid for the header.
- 144 Character data too long  
The character data element contains more than twelve characters (see *IEEE 488.2 7.7.1.4*).
- 148 Character data not allowed  
A legal character data element was encountered where prohibited by the **device**.
- 158 String data not allowed  
A string data element was encountered but was not allowed by the **device** at this point in parsing.
- 168 Block data not allowed  
A legal block data element was encountered but was not allowed by the **device** at this point in parsing.
- 178 Expression data not allowed  
A legal expression data was encountered but was not allowed by the **device** at this point in parsing.

---

<b>HP-IB Execution Errors</b>	-221	Settings conflict
		Indicates that a legal program data element was parsed but could not be executed due to the current device state (see <i>IEEE 488.2 6.4.5.3</i> and <i>11.5.1.1.5</i> ).
	-222	Data out of range
		Indicates that a legal program data element was parsed but could not be executed because the interpreted value was outside the legal range as defined by the <b>device</b> (see <i>IEEE 488.2, 11.5.1.1.5</i> ).

---

<b>HP-IB Device-Specific Errors</b>	-330	Self-test failed
	-350	Queue overflow
		A specific code entered into the queue in lieu of the code that caused the error. This code indicates that there is no room in the queue and an error occurred but was not recorded.

---

<b>HP-IB Query Errors</b>	-410	Query INTERRUPTED
		Indicates that a condition causing an INTERRUPTED Query error occurred (see <i>IEEE 488.2, 6.3.2.3</i> ). For example, a query followed by DAB or GET before a response was completely sent.
	-420	Query UNTERMINATED
		Indicates that a condition causing an UNTERMINATED Query error occurred (see <i>IEEE 488.2, 6.3.2.2</i> ). For example, the <b>device</b> was addressed to talk and an incomplete program message was received.
	-430	Query DEADLOCKED
		Indicates that a condition causing a DEADLOCKED Query error occurred (see <i>IEEE 488.2, 6.3.1.7</i> ). For example, both input buffer and output buffer are full and the device cannot continue.
	-440	Query UNTERMINATED after indefinite response
		Indicates that a query was received in the same program message after an query requesting an indefinite response was executed (see <i>IEEE 488.2 6.5.7.5</i> ).
		Five second self test ...
		This message appears when the command <code>*tst?</code> is sent to the instrument over the HP-IB bus. The instrument runs a

subset of its power-up tests when this message is displayed.  
The local key is disabled during this time.

---

## **Service Messages**

Messages numbered 500 and above relate to the service self tests provided within the instrument. For information about troubleshooting the instrument, refer to Chapter 5, "Service."



## HP-IB Programming

---

### Background

This signal generator adheres to the IEEE 488.1-1987, IEEE 488.2-1987 and SCPI Version 1992.0 command language.

In 1987, the IEEE released IEEE 488.2-1987, Codes, Formats, Protocols and Common Commands for Use with IEEE 488.1-1987. This standard defined the roles of instruments and controllers in a measurement system and a structured scheme for communication. In particular, IEEE 488.2 described how to send commands to instruments and how to send responses to controllers. It defined some frequently used housekeeping commands explicitly, but each instrument manufacturer was left with the task of naming any other types of commands and defining their effect. IEEE 488.2 specified how certain types of features should be implemented if they were included in an instrument. It generally did not specify which features or commands should be implemented for a particular instrument. Thus, it was possible that two similar instruments could each conform to IEEE 488.2, yet they could have an entirely different command set.

Standard Commands for Programmable Instruments (SCPI) is the new instrument command language for controlling instruments that goes beyond IEEE 488.2 to address a wide variety of instrument functions in a standard manner. SCPI promotes consistency, from the remote programming standpoint, between instruments of the same class, and between instruments with the same functional capability.

---

## Programming Guidelines

<b>HP-IB Definition</b>	HP-IB stands for Hewlett-Packard Interface Bus, and is often referred to as the bus. It is Hewlett-Packard's implementation of the IEEE 488.1-1987 and the IEEE 488.2-1987 Standard Digital Interface for Programmable Instrumentation.
<b>What is Programmable</b>	All functions are programmable except the front panel power key, knobs, memory keys, increment set key, arrow keys, frequency reference keys and the rear panel display contrast control.
<b>HP-IB Address</b>	The HP-IB Address for the signal generator is preset to 19. It may be changed to any address between 00 and 30, by pressing <b>ADRS</b> and the desired two-digit number.
<b>Error Messages</b>	The HP-IB programming error messages are described in Chapter 1c, "Operation Messages."
<b>Programming Language</b>	Although many system controllers and programming software languages are compatible with this instrument, all examples and references in this manual assume the use of an HP controller utilizing the HP BASIC programming language.
<b>Query</b>	Most instrument settings may be queried via HP-IB. The data returned from the query will vary from a yes/no (1/0) to the actual setting, depending on the function. See Table 2-1.
<b>Advanced Programming</b>	For the majority of applications, remotely programming the signal generator requires only basic programming knowledge and the command statements listed later in this chapter. Developing programs for querying the instrument's status is considered to be an advanced application (see "HP-IB Status Reporting.") For more information on HP-IB programming see the <i>Tutorial Description of the Hewlett-Packard Interface Bus</i> (HP Part number 5952-0156).

---

## Programming Examples

Examples are provided here to help you understand the required programming structure. All examples use the HP BASIC programming language. See Table 2-1 for a complete listing of commands.

---

### Note

Command statements may be concatenated on the same line if separated by a semicolon. A colon must precede successive command statements to ensure command hierarchy.

---

### Programming RF Frequency

```
OUTPUT 719; "FREQ: CW 500 MHZ"
```

OUTPUT	The output statement (HP BASIC) tells the system controller to output what follows.
7	The Input/Output select code of the system controller is 7.
19	The HP-IB address of the signal generator is 19.
Semicolon (;)	A semicolon separates the HP BASIC command from the output string that follows.
Quotes (" ")	All command statements must be contained in quotes.
FREQ: CW	This command programs the RF frequency. FREQ must be in the statement first representing its hierarchy over :CW. The colon (:) is used to separate the command hierarchy. The signal generator will be programmed to a RF frequency of 500 MHz.

### Programming RF Frequency and FM Modulation

```
OUTPUT 719; "FREQ: CW 500 MHZ; :FM: DEV 3 KHZ; :FM: SOUR  
EXT; :FM: EXT: COUP AC; :AM: STAT OFF; :PM: STAT OFF; :FM: STAT  
ON"
```

FM: DEV	This command programs the FM deviation. FM is higher than DEV in the command hierarchy and is separated by a colon (:). The signal generator will be programmed to 3 kHz of deviation.
Semicolon (;)	A semicolon separates completed command statements.
FM: SOUR: EXT	This command selects the external path for the modulation source.
FM: EXT: COUP AC	This command selects ac coupling.
FM: STAT ON	This command changes the FM modulation to an on state. A modulation format must be turned on before it is active. The other two modulation formats must be turned off prior to activating the desired modulation (AM: STAT OFF and PM: STAT OFF).

## Querying RF Frequency

```
100 OUTPUT 719; "FREQ: CW?"  
200 ENTER 719; Freq_set  
300 PRINT "Frequency is"; Freq_set; "Hz"
```

Line 100 This command outputs a query for the RF frequency setting. You may attach a question mark (?) to any of the signal generators' commands to query its setting.

Line 200 This command enters the queried frequency setting into the variable Freq\_set.

Line 300 This command prints the queried frequency setting.

## Programming RF Amplitude

```
OUTPUT 719; "POW: AMPL -47 DBM; :OUTP: STAT ON"
```

POW:AMPL This command programs the RF amplitude. POW is higher than AMPL in the command hierarchy and is separated by a colon. The signal generator's RF amplitude will be programmed to -47 dBm.

OUTP:STAT ON This command changes the RF amplitude to an on state. The RF amplitude defaults to an off state when the instrument is powered on.

**Table 2-1. Programming Command Statements and Descriptions**

Command Statement	Description	Query
<b>Amplitude</b>		
OUTP:STAT ON	Turns the RF output on.	OUTP:STAT?
OUTP:STAT OFF	Turns the RF output off.	
POW:AMPL <value> <units>	Sets the amplitude of the RF output to the desired <value> and <units>. <value> may be up to 4 digits plus a sign if applicable, e.g. -127.1 or maximum resolution of .1 dB, .001 mV, .01 $\mu$ V. <units> may be DBM, MV, UV, MVEMF, UVEMF, DBUV, DBUVEMF. If in reference mode only DB or DBM are allowed.	POW:AMPL?
POW:ATT:AUTO ON	Turns automatic attenuator control on (this is normally on).	POW:ATT:AUTO?
POW:ATT:AUTO OFF	Turns automatic attenuator control off and holds present attenuator setting.	
POW:REF <value> <units>	Sets a reference to the <value> in <units> as described in setting amplitude. Reference state must be on, to be active.	POW:REF?
POW:REF:STAT ON	Sets reference to on, making all amplitude changes relative to the reference.	POW:REF:STAT?
POW:REF:STAT OFF	Sets reference to off, making all amplitude changes absolute.	
<b>Frequency</b>		
FREQ:CW <value> <units>	Sets the RF frequency to the <value> and <units>. <value> may be up to 9 digits with a maximum of 10 Hz resolution. <units> may be MHZ, KHZ or HZ.	FREQ:CW?
<b>Modulation</b>		
<b>Amplitude Modulation</b>		
AM:DEPT <value> PCT	Sets AM depth in %, <value> from .1 to 99.9	AM:DEPT?
AM:STAT ON	Sets AM on, FM and PM must have state off.	AM:STAT?
AM:STAT OFF	Sets AM off.	
AM:SOUR INT	Selects internal source.	AM:SOUR?
AM:SOUR EXT	Selects external source.	
AM:SOUR INT,EXT	Selects internal and external sources	
AM:INT:FREQ 1 KHZ	Selects internal 1 kHz frequency.	AM:INT:FREQ?
AM:INT:FREQ 400 HZ	Selects internal 400 Hz frequency.	
AM:EXT:COUP DC	AM cannot be dc-coupled (SCPI allows command).	AM:EXT:COUP?
AM:EXT:COUP AC	Selects external ac-coupling for AM.	
<b>Frequency Modulation</b>		
CAL:DCFM	Eliminates dc FM offset.	
FM:DEV <value> KHZ	Sets FM deviation in kHz, <value> from 0.00 to 9.99 and 10.0 to 99.9, <value> may also be entered in Hz (HZ).	FM:DEV?
FM:STAT ON	Sets FM on, AM and PM must have state off.	FM:STAT?
FM:STAT OFF	Sets FM off.	
FM:SOUR INT	Selects internal source for FM.	FM:SOUR?
FM:SOUR EXT	Selects external source for FM.	
FM:SOUR INT,EXT	Selects internal and external source.	
FM:INT:FREQ 1 KHZ	Selects internal 1 kHz frequency.	FM:INT:FREQ?
FM:INT:FREQ 400 HZ	Selects internal 400 Hz frequency.	
FM:EXT:COUP DC	Selects external dc coupling for FM.	FM:EXT:COUP?
FM:EXT:COUP AC	Selects external ac coupling for FM.	

**Table 2-1. Programming Command Statements and Descriptions (continued)**

Command Statement	Description	Query
<b>Modulation (continued)</b>		
<b>Phase Modulation</b>		
PM:DEV <value> RAD	Set phase modulation in radians (RAD), <value> from 0.00 to 9.99 and 10.0	PM:DEV?
PM:STAT ON	Sets PM on. AM and FM must have state off.	PM:STAT?
PM:STAT OFF	Sets PM off.	
PM:SOUR INT	Selects internal source for PM.	PM:SOUR?
PM:SOUR EXT	Selects external source for PM.	
PM:SOUR INT,EXT	Selects internal and external source.	
PM:INT:FREQ 1 KHZ	Selects internal 1 kHz frequency.	PM:INT:FREQ?
PM:INT:FREQ 400 HZ	Selects internal 400 Hz frequency.	
PM:EXT:COUP DC	Selects external dc coupling for PM.	PM:EXT:COUP?
PM:EXT:COUP AC	Selects external ac coupling for PM.	
<b>Standard Commands for Status</b>	<i>See HP-IB Status Reporting examples</i>	
STAT:QUES:POW:ENAB<NR1>	Returns contents of the power condition register. Enables <NR1> event registers for power.	STAT:QUES:POW:COND?
	Returns contents of enabled event registers for power.	STAT:QUES:POW:EVEN?
STAT:QUES:MOD:ENAB<NR1>	Returns contents of the modulation condition register Enables <NR1> event registers for modulation.	STAT:QUES:MOD:COND?
	Returns contents of enabled registers for modulation.	STAT:QUES:MOD:EVEN?
<b>IEEE 488.2 Common Commands</b>		
*RST	Resets the signal generator to a default state (see SCPI Command Reference). Returns the instrument's identity.	*IDN?
	Executes an instrument self-test.	*TST?
*WAI	Instrument waits until previous commands are completed.	
*CLS	Clears status and event registers.	
*ESE <dec. num. data>	Enables Standard Event Status Register bits. Queries the Standard Event Status Enable Register.	*ESE?
	Queries the Standard event Status Register.	*ESR?
*OPC	Enables the Operation Complete bit of the Standard Event Status Register. Queries the Operation Complete bit of the Standard Event Register.	*OPC?
*SRE <dec. num. data>	Enables the bits in the Status Byte that will cause a Service Request. Queries the Service Request Enable Register.	*SRE?
	Queries the Status Byte with the MSS bit.	*STB?

## HP-IB Status Reporting

The IEEE 488.2 standard provides a status byte for instrument status reporting. This status byte may be accessed by using IEEE 488.2 Common Commands and SCPI Status Commands. The following figure shows the status reporting structure for instrument operation.

The following examples will be used to explain instrument operation status.

- External Modulation Input Status
- Reverse Power Protection Status
- Unspecified Power (Amplitude) Entry Status

General IEEE 488.2 status reporting will not be covered. The above operating status will satisfy most needs for status reporting.

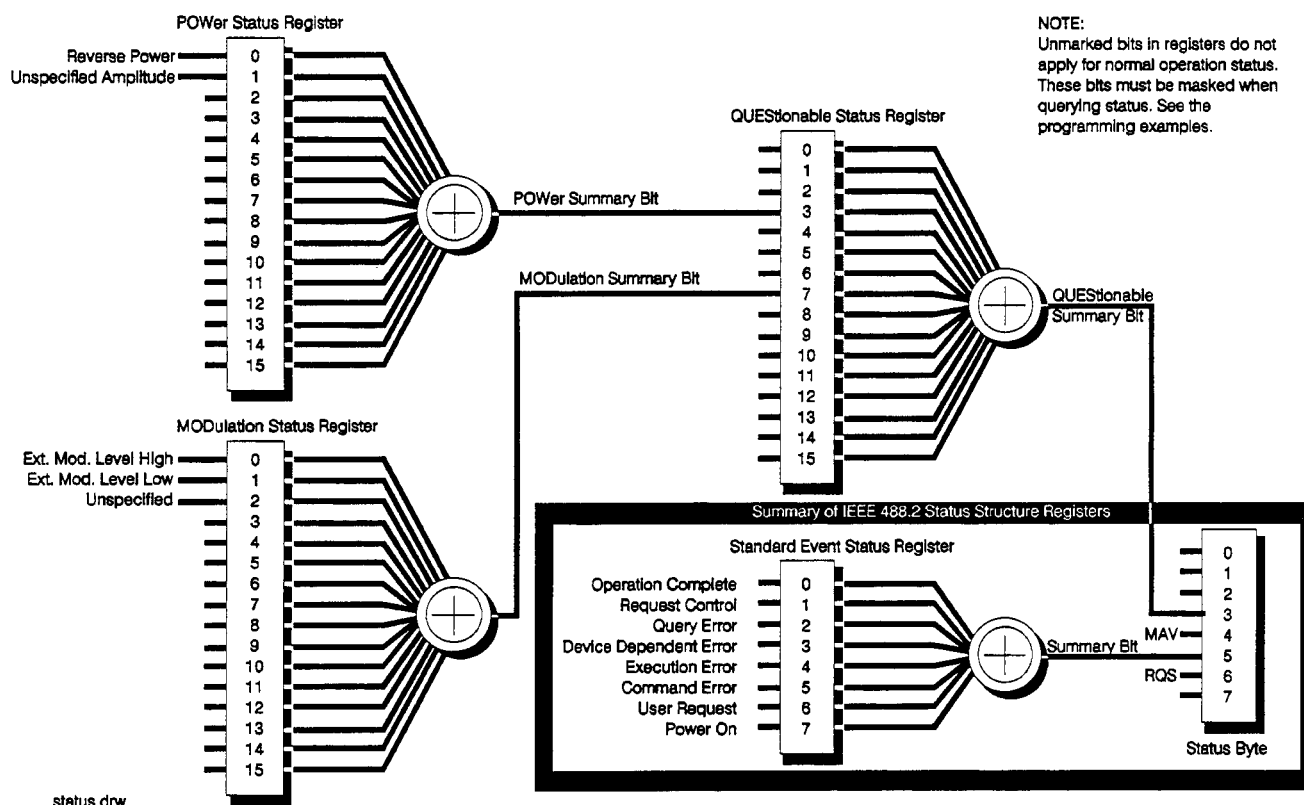

Figure 2-1. HP 8647A Status Register Model

## External Modulation Input Level Status

External modulation input level status may be queried for high, low or input level correct. The instrument automatically detects the input level (1 Vpk into 600 ohms for full scale modulation) and displays the result on the front panel display but must be queried for HP-IB reporting.

### Example: Check the Condition of Modulation Input (High or Low)

```
10 OUTPUT 719; "STAT:QUES:MOD:COND?"
20 ENTER 719; Value
30 Mod=BINAND(Value,1)
40 IF Mod=1 THEN PRINT "Ext.Mod.Input High"
50 Mod=BINAND(Value,2)
60 IF Mod=2 THEN PRINT "Ext.Mod.Input Low"
70 END
```

- Line 10            Queries the condition of the MODulation register. Besides querying the condition you may also query if an event has occurred, such as the external modulation input being high or low at some previous time. Replace the COND? with EVEN? to read the event status. Reading the event status clears the register.
- Line 20            Enters the condition of the MODulation register into the variable "Value".
- Line 30            Uses the HP Basic command, BINAND to check the contents of bit 0 in "Value". If bit 0 is a "1" it will be reported as a decimal equivalent "1" and "Mod" will equal "1".
- Line 40            Checks if the MODulation condition is "1" and if true, prints that the external modulation input is high.
- Line 50            Uses the HP Basic command, BINAND to check the contents of bit 1 in "Value". If bit 1 (decimal equivalent "2") is a "1", "Mod" will equal "1".
- Line 60            Checks if the MODulation condition is "2" and if true, prints that the external modulation input is low.



### **Example: Generate a Service Request for External Modulation Input (High or Low)**

```
10 OUTPUT 719; "STAT:QUES:MOD:ENAB 3"  
20 OUTPUT 719; "STAT:QUES:ENAB 128"  
30 OUTPUT 719; "*SRE 8"  
40 IF SPOLL(719) THEN PRINT "Ext. Mod. Input High/Low  
   Detected"  
50 OUTPUT 719; "*CLS"  
60 END
```

- Line 10            Enables bits 0 and 1 (decimal equivalent 3) in the MODulation register. Enabling these bits masks other bits in the MODulation register from reporting their status in the summary bit to QUEStionable.
- Line 20            Enables bit 7 (decimal equivalent 128) in the QUEStionable register. Enabling this bit masks other bits in the QUEStionable register from reporting their status in the summary bit to STATus.
- Line 30            Enables bit 3 (decimal equivalent 8) of the STATus register. Enabling this bit masks other bits from reporting.
- Line 40            Uses the HP Basic command, SPOLL, (Serial Poll) to see if the service request bit is reporting any interrupts.
- Line 50            Clears all status registers. Clearing the status registers is not absolutely necessary, but is used here because of the unknown state of the instrument.

## Reverse Power Protection Status

This instrument provides protection from signals inadvertently applied to the RF output of the instrument. This protection is commonly called reverse power protection (RPP). The instrument automatically detects the reverse power, which in turn, disconnects the instruments RF output. When the RPP engages, the front panel display will read RF OFF but must be queried for HP-IB reporting.

### Example: Check the condition of the RPP

```
10 OUTPUT 719; "STAT:QUES:POW:COND?"
20 ENTER 719; Value
30 Rpp=BINAND(Value,1)
40 IF Rpp=1 THEN PRINT "RPP is engaged"
50 IF Rpp=1 THEN INPUT "Is reverse power input
corrected(Y/N)",A#
60 IF A#="Y" THEN OUTPUT719; "OUTP:STAT ON"
70 END
```

- |         |   |
|---------|---|
| Line 10 | Queries the condition of the POWER register.  |
| Line 20 | Enters the condition of the POWER register into the variable "Value".   |
| Line 30 | Uses the HP Basic command, BINAND to check the contents of bit 0 in "Value". If bit 0 is a "1", "Rpp" will equal "1". |
| Line 40 | Checks if the RPP condition is "1" and if true prints that the RPP is engaged.  |
| Line 50 | Checks if RPP condition is "1" and if true asks if the situation has been corrected.                                  |
| Line 60 | Checks if the answer was yes to correction and if true turns the RF output on to reset the RPP.                       |

## Unspecified Power (Amplitude) Entry Status

This instrument provides a message if an amplitude entry is requested above +10 dBm and less than or equal to +13 dBm or an attenuator hold range is exceeded (see operating part of manual). When an unspecified amplitude is entered, the front panel display will read "Amplitude exceeds specified range," but must be queried for HP-IB reporting.

### Example: Check the Condition of Unspecified Power Entry

```
10 OUTPUT 719; "STAT:QUES:POW:COND?"
10 ENTER 719:Value
30 Pow_spec=BINAND(Value,2)
40 IF Pow_spec=2 THEN PRINT "Amplitude unspecified"
50 END
```

- Line 10           Queries the condition of the POWER register. Besides querying the condition you may also query if an event has occurred. Replace the COND? with EVEN? to read the event status. Reading the event status clears the register.
- Line 20           Enters the condition of the POWER register into the variable "Value".
- Line 30           Uses the HP Basic command, BINAND to check the contents of bit 1 in "Value". If bit 1 is "high", Pow\_spec will equal "2".
- Line 40           Checks if Pow\_spec equals 2 and then prints that the amplitude is in an unspecified range.

# HP 8647A SCPI

## Command Reference

**Table 2-2. Dictionary of Terms**

Terms	Description
<NRf>	Indicates an ASCII representation of a number if required in the command statement. The number may be an integer or floating-point, and may include a decimal exponent. (nrf stands for "flexible numeric representation". For further information, refer to the IEEE 488.2 standard.)
<NR1>	Indicates an ASCII representation of a number if required in the command statement. The number must be an integer and may not include decimal points. For further information, refer to the IEEE 488.2 standard.)
<AM term>	Indicates that a "PCT" termination is required in the command statement. If no termination is specified, a "PCT" value is assumed.
<freq term>	Indicates that a "HZ", "KHZ", "GHZ", or "MHZ" termination is required in the command statement. IF the command is not terminated then "HZ" is assumed.
<angle term>	Indicates that a "RAD" termination is required in the command statement. If no termination is specified then "RAD" is assumed.
<ampl term>	Indicates that a "DB", "DBM", "DBUV", "UV", "MV", "V", "UVEMF", "MVEMF", or "DBUVEMF" termination is required in the command statement. If no termination is specified then "DBM" is assumed.
[command]	Bracketed commands are optional. SCPI assumes the optional command is present.
param   param	Parameters separated by " " indicates that either parameter is acceptable.
param,param	Parameters separated by "," indicates that multiple parameters are allowed.

## AM Subsystem

```
[SOURce]
:AM
[:DEPTh]?
[:DEPTh] <NRf> [<AM term>]
```

Sets AM depth in percent. \*RST value is 30%.

```
:STATe?
:STATe ON | OFF | 1 | 0
```

Turns AM modulation ON or OFF. AM is not turned on by just setting AM:DEPTh. Turning AM modulation ON will not automatically turn OFF any other types of modulation. Turning any or all modulation types ON or OFF must be done explicitly. If a modulation type is turned ON while another modulation type is ON, an execution error -221 is generated, and the state of the instrument is unchanged. \*RST value is OFF.

```
:SOURce?
:SOURce INTernal | EXTernal [,INTernal | ,EXTernal]
```

Selects AM source. \*RST value is INTernal.

```
:EXTernal
:COUPling?
:COUPling AC | DC
```

Sets source coupling for AM. The GROund parameter defined by the 1991 SCPI Command Reference (17.1.9.2) is not supported. \*RST value is DC.

```
:INTernal
:FREQUency?
:FREQUency <NRf> [<freq term>]
```

Sets the frequency of the AM internal signal source. Legal values are 400 Hz and 1 kHz. \*RST value is 1 kHz.

## CAL Subsystem

```
[SOURce]
:CAL
:DCFM
```

Eliminates the offset in dc FM so that the carrier frequency remains the same with no modulation applied. External dc modulation must be on to implement this calibration or execution error -221 is generated.

## FM Subsystem

[SOURce]

:FM

[:DEVIation]?

[:DEVIation] <NRf> [<freq term>]

Sets FM deviation. \*RST value is 3 kHz.

:STATe?

:STATe ON | OFF | 1 | 0

Turns FM modulation ON or OFF. FM is not turned on by just setting FM:DEVIation. Turning FM modulation ON will not automatically turn OFF any other types of modulation. Turning any or all modulation types ON or OFF must be done explicitly. If a modulation type is turned ON while another modulation type is ON, an execution error -221 is generated, and the state of the instrument is unchanged. \*RST value is OFF.

:SOURce?

:SOURce INTernal | EXTernal [,INTernal |,EXTernal]

Selects FM source. \*RST value is INTernal.

:EXTernal

:COUPling?

:COUPling AC | DC

Sets source coupling for FM. The GROund parameter defined by the 1991 SCPI Command Reference (17.4.9.2) is not supported. \*RST value is DC.

:INTernal

:FREQuency?

:FREQuency <NRf> [<freq term>]

Sets the frequency of the FM internal signal source. Legal values are 400 Hz and 1 kHz. \*RST value is 1 kHz.

## **FREQuency Subsystem**

```
[SOURce]
:FREQuency
[:CW | :FIXed]?
[:CW | :FIXed] <NRf> [<freq term>]
```

This function selects a frequency for the continuous wave non-swept signal. \*RST value is 100 MHz.

## **OUTPut Subsystem**

```
OUTPut
:STATe?
:STATe ON | OFF | 1 | 0
```

This function controls the state of the RF output. When OUTPut:STATe is OFF, the RF source level is set to off. Turning OUTPut:STATe ON causes the programmed CW signal to be present at the output terminal. \*RST value is OFF.

## PM Subsystem

[SOURce]

:PM

[:DEVIation]?

[:DEVIation] <NRf> [<angle term>]

Sets PM deviation in radians. \*RST value is 1.0 RAD.

:STATe?

:STATe ON | OFF | 1 | 0

Turns PM modulation ON or OFF. PM is not turned on by just setting PM:DEVIation. Turning FM modulation ON will not automatically turn OFF any other types of modulation. Turning any or all modulation types ON or OFF must be done explicitly. If a modulation type is turned ON while another modulation type is ON, an execution error -221 is generated, and the state of the instrument is changed. \*RST value is OFF.

:SOURce?

:SOURce INTernal | EXTernal [,INTernal | ,EXTernal]

Selects PM source. \*RST value is INTernal.

:EXTernal

:COUPling?

:COUPling AC | DC

Sets source coupling for PM. The GROund parameter defined by the 1991 SCPI Command Reference (17.10.9.2) is not supported. \*RST value is DC

:INTernal

:FREQuency?

:FREQuency <NRf> [<freq term>]

Sets the frequency of the PM internal signal source. Legal values are 400 Hz and 1 kHz. \*RST value is 1 kHz.



**POWer Subsystem** [SOURce]  
:POWer  
[:LEVel] [:IMMediate] [:AMPLitude]?

Returns the value of the current CW amplitude. The return value is in units of DBM if POWer:REFerence:STATe is OFF, or it is in DB, relative to the current value of POWer:REFerence if POWer:REFerence:STATe is ON.

[:LEVel] [:IMMediate] [:AMPLitude] <NRf> [<ampl term>]

Sets CW amplitude. \*RST value is -136 dBm.

:ATTenuation  
:AUTO?  
:AUTO ON | OFF | 1 | 0

When set ON, the firmware will control the attenuators. Turning it OFF causes the attenuator range to hold to it's present setting. \*RST value is ON

:REFerence?  
:REFerence <NRf> [<ampl term>]

Sets a reference value which, if STATe is ON, allows all amplitude parameters to be queried/set as relative to the reference value. \*RST value is 0 dBm.

:STATe?  
:STATe ON | OFF | 1 | 0

Determines whether amplitude is output in absolute or relative mode. \*RST value is OFF.

## STATUS Subsystem

STATUS  
:QUESTIONable  
[:EVENT]?

Returns the contents of the event register associated with the status structure.

:CONDition?

Returns the contents of the condition register associated with the status structure. Reading the condition register is nondestructive.

:ENABLE <NR1>

Sets the enable mask which allows true conditions in the event register to be reported in the summary bit.

:ENABLE?

Queries the enable mask.

:POWER  
[:EVENT]?  
:CONDition?  
:ENABLE <NR1>  
:ENABLE?

:MODulation  
[:EVENT]?  
:CONDition?  
:ENABLE <NR1>  
:ENABLE?

## **SYSTEM Subsystem**

**SYSTEM**  
**:ERRor?**

Returns any system error message. The format of the response is <error number>,<error string>.

**:VERSion?**

Returns a formatted numeric value corresponding to the SCPI version number for which the instrument complies. The format of the response is YYYY.V. The Ys represent the year version (for example, 1990) and the V represents an approved revision number for that year.

---

## HP-IB Capabilities

The instrument is designed to be compatible with a controller that interfaces in terms of the bus codes summarized in the table. This table describes each of the interface functions that are available with this instrument as defined by the IEEE 488.2-1987

**Table 2-3. IEEE 488.2 Capabilities**

Capability	Code	Comment
Source Handshake	SH1	Full Capability
Acceptor Handshake	AH1	Full Capability
Talker	T6, TE0	Basic Talker, Serial Poll, untalk on MLA
Listener	L4, LE0	Basic Listener, unlisten on MTA
Service Request	SR1	Full Capability
Remote Local	RL1	Full Capability
Parallel Poll	PP0	No Capability
Device Clear	DC1	Full Capability
Device Trigger	DT0	No Capability
Controller	C0	No Capability
Electrical Interface	E2	Tristate (1 MB/sec Max)

# HP-IB Connector Information



## Hewlett-Packard Interface Bus

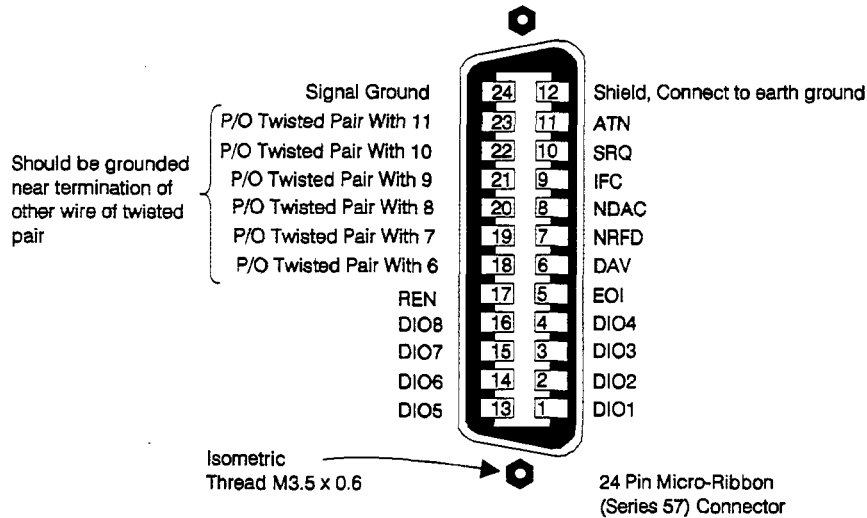

### Logic Levels

The Hewlett-Packard Interface Bus logic levels are TTL compatible, that is, the true (1) state is 0.0 Vdc to +0.4 Vdc and the false state (0) is +2.5 Vdc to +5 Vdc.

### Mating Connector

HP 1251-0293; Amphenol 57-30240

### Mating Cables Available

HP 10833A, 1 meter (3.3 ft.)  
 HP 108033B, 2 meters (6.8 ft.)  
 HP 10833C, 4 meters (13.2 ft.)  
 HP 10833D, 0.5 meters (1.6 ft.)

### Cabling Restrictions

1. A Hewlett-Packard Interface Bus system may contain no more than 2 meters (6.6 ft.) of connecting cable per instrument.
2. The maximum accumulative length of connecting cable for any Hewlett-Packard Interface Bus system is 20 meters (65.5 ft.).

## Installation

---

### Unpacking Your Signal Generator

1. Unpack the contents of the shipping container.
2. Inspect the shipping container for damage.

If the shipping container is damaged or the cushioning material inside is stressed, keep them until you have checked the instrument for proper operation.

3. Inspect the signal generator to ensure that it was not damaged during shipment.

If mechanical damage or defects have occurred, notify the carrier as well as the Hewlett-Packard office. Keep the shipping materials for inspection by the carrier.

#### Warning

---

**To avoid hazardous electrical shock, do not connect AC power to the instrument when there are any signs of shipping damage to any portion of the outer enclosure (cover and panels).**

---

#### Caution

---

**Ventilation Requirements:** When installing the instrument in a cabinet, the convection into and out of the instrument must not be restricted. The ambient temperature (outside the cabinet) must be less than the maximum operating temperature of the instrument by 4 °C for every 100 watts dissipated in the cabinet. If the total power dissipated in the cabinet is greater than 800 watts, then forced convection must be used.

---



---

## Connecting AC Power

#### Warning

---

**This is a Safety Class I product (provided with a protective earthing ground incorporated in the power cord). The mains plug shall only be inserted in a socket outlet provided with a protective earth contact. Any interruption of the protective conductor, inside or outside the instrument, is likely to make the instrument dangerous. Intentional interruption is prohibited.**

**If this instrument is to be energized via an external autotransformer for voltage reduction, make sure that its common terminal is connected to a neutral (earthed pole) of the power supply.**

---

This instrument is equipped with a three-wire power cable. When connected to an appropriate ac power receptacle, this cable grounds

the instrument cabinet. The type of Mains plug shipped with each instrument depends on the country of destination. Refer to Figure 3-2 for the part numbers of the power cables and mains plugs available.

## Power Requirements

The signal generator requires a power source of either 50/60/400 Hz at 100/120 V or 50/60 Hz at 200/240 V. The voltage ranges for these nominal voltage values are shown in Table 3-1. Power consumption is 150 VA maximum.

**Table 3-1. Voltage Ranges for Nominal Voltage Values**

Available ac Voltage	Voltage Range
100 V	90 to 110 V rms
120 V	108 to 132 V rms
220 V	198 to 242 V rms
240 V	216 to 250 V rms

## Caution

---

This instrument has autoranging line voltage input; be sure the supply voltage is within the specified range.

---

## Replacing the Fuse

If a fuse failure is suspected, replace the 250 V, 3A, type F fuse (HP part number 2110-0780) as follows:

1. Unplug the power cord from the line module.
2. Use a flat-bladed screw driver to pry and unseat the fuse housing from the line module.
3. Remove the cartridge and inspect the fuse positioned toward the front of the instrument.

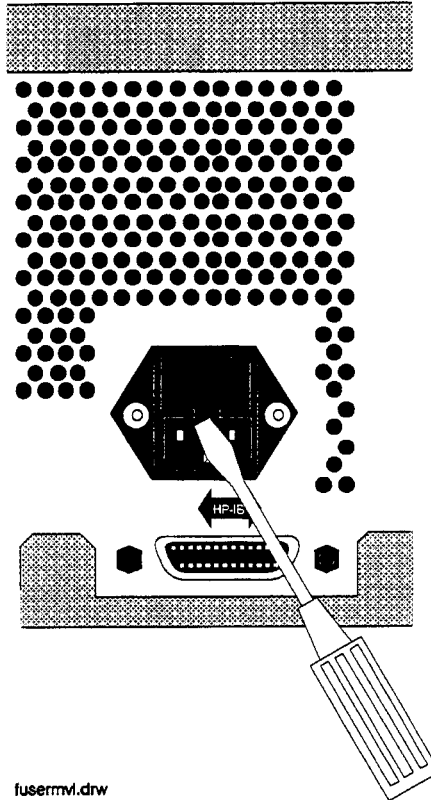

fusermv1.drw

**Figure 3-1. Replacing the Fuse**

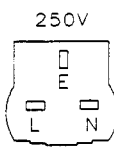
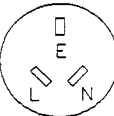
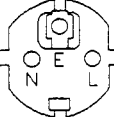
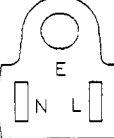
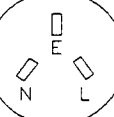

PLUG TYPE **	CABLE HP PART NUMBER	PLUG DESCRIPTION	CABLE LENGTH CM (INCHES)	CABLE COLOR	FOR USE IN COUNTRY
250V 	8120-1351 8120-1703	Straight* BS1363A 90°	229 (90) 229 (90)	Mint Gray Mint Gray	Great Britain, Cyprus, Nigeria, Singapore, Zimbabwe
250V 	8120-1369 8120-0696	Straight* NZSS198/ASC112 90°	201 (79) 221 (87)	Gray Gray	Argentina, Australia, New Zealand, Mainland China
250V 	8120-1689 8120-1692	Straight* CEE7-Y11 90°	201 (79) 201 (79)	Mint Gray Mint Gray	East and West Europe, Central African Republic, United Arab Republic (unpolarized in many nations)
125V 	8120-1348 8120-1538	Straight* NEMA5-15P 90°	203 (80) 203 (80)	Black Black	United States Canada, Japan (100 V or 200 V), Brazil, Colombia, Mexico, Philippines, Saudia Arabia, Taiwan
	8120-1378 8120-4753 8120-1521 8120-4754	Straight* NEMA5-15P Straight 90° 90°	203 (80) 230 (90) 203 (80) 230 (90)	Jade Gray Jade Gray Jade Gray Jade Gray	
250V 	8120-5182 8120-5181	Straight* NEMA5-15P 90°	200 (78) 200 (78)	Jade Gray Jade Gray	Israel
<p>* Part number for plug is industry identifier for plug only. Number shown for cable is HP Part Number for complete cable, including plug.</p> <p>** E = Earth Ground; L = Line; N = Neutral.</p>					

FORMAT80

**Figure 3-2. Power Cable and Mains Plug**

---

## Turning On the Signal Generator

If you are operating this instrument in extreme environmental conditions, refer to the following operation limitations.

The following minimum conditions are required for safe operation of this instrument:

- Indoor use
- Altitude < 4572 meters (15,000 feet)
- Temperature: 0 ° to 50 °C, unless specified differently
- Maximum relative humidity 80% for temperatures up to 31 °C decreasing linearly to 50% relative humidity at 40 °C

The instrument performs a diagnostic self test on power-up. If any problems are detected with functionality it will display a message. Refer to Chapter 1c, "Operation Messages," for further information about the messages.

### Caution

---

This instrument is designed for use in Installation Category II and Pollution Degree 2 per IEC 1010 and 664 respectively.

---

---

## Connecting to Other Instruments

Coaxial mating connectors used with the signal generator should be either 50Ω BNC or 50Ω type N male connectors that are compatible with those specified in UL MIL-C-39012.

---

## Storing the Signal Generator

The instrument should be stored in a clean, dry environment. The following environmental limitations apply to both storage and shipment.

- Temperature -20 °C to +70 °C
- Humidity < 95% relative
- Altitude 15,300 meters (50,000 feet)

### Note

---

The cabinet should only be cleaned using a damp cloth.

---

---

## Shipping the Signal Generator

Containers and materials identical to those used in factory packaging are available through Hewlett-Packard offices. If the instrument is being returned to Hewlett-Packard for servicing, attach a tag indicating the type of service required, return address, model number, and full serial number. Also, mark the container *FRAGILE* to assure careful handling. In any correspondence, refer to the instrument by model number and full serial number.

If you are using other packaging, follow the guidelines below:

1. Wrap the instrument in heavy paper or plastic.
2. Use a strong shipping container. A double-wall carton made of 2.4 MPa (350 psi) test material is adequate.
3. Use enough shock-absorbing material (75 to 100 millimeter layer; 3 to 4 inches) around all sides of the instrument to provide a firm cushion and to prevent movement in the container. Protect the front-panel with cardboard.
4. Seal the shipping container securely.
5. Mark the shipping container *FRAGILE* to assure careful handling.

## Specifications

---

This chapter contains specifications and supplemental characteristics for the HP 8647A signal generator.

- Specifications describe the instrument's warranted performance over the 0 to 50° temperature range and apply after a 30 minute warm-up unless otherwise noted. All performance below a carrier frequency of 250 kHz is typical.
- Supplemental characteristics (shown in italics) are intended to provide information useful in estimating instrument capability in your application by describing typical, but non-warranted performance.

## Frequency Specifications

Range	250 kHz to 1000 MHz
Resolution	1 Hz
Display	10 Hz
Accuracy*	<i>Typically <math>\pm 8 \times 10^{-6}</math> x carrier frequency in Hz, <math>\pm 1.5 \times 10^{-6}</math> x carrier frequency for Option 1E5.</i>
* After one hour warm-up and within one year of calibration.	
Switching Speed	< 120 ms

## Internal Reference Oscillator

Accuracy and stability* (calibration and adjustment dependent)	$\pm$ Aging rate $\pm$ temperature effects $\pm$ line voltage effects
* After one hour warm-up and within one year of calibration	

	Standard Timebase	High Stability Timebase Opt. 1E5
Aging	< $\pm 2$ ppm/year	< $\pm 0.5$ ppm/year*
Temperature	< $\pm 1$ ppm	< $\pm 0.05$ ppm
Line Voltage†	< $\pm 0.5$ ppm	< $\pm 0.1$ ppm
* The aging rate is < $\pm 1$ ppm in the first year. † Specification applies for a line voltage change of $\pm 5\%$ .		

Output	10 MHz, typically > 0.5 $V_{rms}$ level into 50 ohms
--------	--

External reference oscillator input	Accepts 2, 5, 10 MHz $\pm 5$ ppm and a level range of 0.5 V to 2 $V_{rms}$ into 50 ohms
-------------------------------------	---

## Output

<b>Range</b>	+10 to -136 dBm
<b>Display Resolution</b>	0.1 dB
<b>Accuracy*</b>	±1.5 dB
* Accuracy is valid from maximum specified output power to -127 dBm. It's typically ±3.0 dB below -127 dBm.	
<b>Reverse power protection</b>	50 watts into 50 ohms
<b>SWR (output &lt; -6 dBm, typical)</b>	2.0:1
<b>Output Impedance</b>	Nominally 50 ohms

## Spectral Purity

<b>Harmonics</b>	< -30 dBc (output ≤ +4 dBm)
<b>Subharmonics (output ≤ +4 dBm)</b>	-60 dBc
<b>Nonharmonics (&gt; 5 kHz offset, ≤ +4 dBm output level)</b>	< -60 dBc*
* Non-harmonic spurious are -55 dBc from 220 to 250 MHz.	
<b>Residual FM (CCITT, rms)</b>	
< 249 MHz	< 20 Hz, typically < 11 Hz
< 501 MHz	< 10 Hz, typically < 6 Hz
≤ 1000 MHz	< 20 Hz, typically < 11 Hz
<b>SSB Phase Noise (at 20 kHz offset, typical)</b>	
at f <sub>c</sub> 500 MHz	< -110 dBc/Hz
at f <sub>c</sub> 1000 MHz	< -106 dBc/Hz

# Frequency Modulation

<b>Peak Deviation</b> (rates > 25 Hz ac FM) < 249 MHz < 501 MHz ≤ 1000 MHz	0 to 100 kHz 0 to 50 kHz 0 to 100 kHz
<b>Resolution</b> ≤ 10% peak deviation > 10% to maximum peak deviation	10 Hz 100 Hz
<b>Deviation Accuracy</b> (internal 1 kHz rate)	±7.5% of FM deviation ±30 Hz
<b>Rates</b> Internal External DC External AC	400 Hz or 1 kHz <i>dc to 75 kHz (typical, 3 dB BW)</i> <i>20 Hz to 75 kHz (typical, 3 dB BW)</i>
<b>Distortion</b> (1 kHz rate, THD + N, 0.3 to 3 kHz BW) (88 to 108 MHz)	< 1% at deviations > 4 kHz (< 0.5% at deviations > 75 kHz)
<b>Carrier frequency accuracy relative to CW in dc FM*</b>	±500 Hz ( <i>typ. 200</i> ) at deviations < 10 kHz
* Specifications apply over the 25 ±5 °C range.	
<b>FM + FM</b>	Internal 1 kHz or 400 Hz source plus external. In internal plus external FM mode, the internal source produces the set level of deviation. The external input should be set to ≤ ±0.5 Vpk or 0.5 Vdc (one-half of the set deviation).

## Phase Modulation

<b>Peak Deviation Range</b> < 249 MHz < 501 MHz ≤ 1000 MHz	0 to 10 radians 0 to 5 radians 0 to 10 radians
<b>Resolution</b>	0.01 radian
<b>Deviation Accuracy</b> (internal 1 kHz rate, typical)	±7.5% of deviation setting ±0.05 radians
<b>Rates</b> Internal External	400 Hz or 1 kHz 20 Hz to 10 kHz (typical, 3 dB BW)
<b>Distortion</b> (1 kHz rate)	< 2% at deviations ≥ 3 radians

## Amplitude Modulation

AM performance is not specified below 1.5 MHz.

<b>Range</b>	0 to 100%; output ≤ 4 dBm
<b>Resolution</b>	0.1%
<b>Accuracy</b> (1 kHz rate)	±5% of setting ±1.5%
<b>Rates</b> Internal External	400 Hz or 1 kHz 20 Hz to 25 kHz (typical, 3 dB BW)
<b>Distortion</b> (1 kHz rate, THD + Noise, 0.3 to 3 kHz BW) at 30% AM at 90% AM	< 2% < 3%



---

## Modulation Source

Internal	400 Hz or 1 kHz, front panel BNC connector provided at nominally 1 V <sub>p-p</sub> into 600 ohms.
External	1 V <sub>p</sub> into 600 ohms (nominal) required for full scale modulation. (High/Low indicator provided for external signals $\leq$ 10 kHz.)

---

## Remote Programming

Interface	HP-IB (IEEE-488.2-1987) with Listen and Talk
Control Languages	SCPI version 1992.0
Functions Controlled	All front panel functions except power switch and knobs.
IEEE-488 Functions	SH1, AH1, T6, TE0, L4, LE0, SR1, RL1, PP0, DC1, DT0, C0, E2

---

## Environmental

Operating temperature range	0 to 50 °C
Shock and vibration	Meets MIL STD 28800E Type III, Class 5, Style E
Leakage	Conducted and radiated interference meets MIL STD 461B RE02 Part 2 and CISPR11. <i>Leakage is typically <math>&lt; 1 \mu V</math> (nominally <math>0.1 \mu V</math> with a 2 turn loop) at <math>\leq 1001</math> MHz, when measured with a resonant dipole antenna one inch from any surface (except the rear panel) with output level <math>&lt; 0</math> dBm (all inputs/outputs properly terminated).</i>

---

## General

Power Requirements	90 to 264 V; 48 to 440 Hz; 170 VA maximum
Internal Diagnostics	Automatically executes on instrument power-up. Assists user in locating instrument errors and locating faulty module.
Storage Registers	300 storage registers with sequence and register number displayed. Up to 10 sequences are available with 30 registers each.
Weight	7 kg (15 lbs) net; 9 kg (20 lbs) shipping
Dimensions	165H x 330W x 333D mm (6.5H x 13W x 13.2D in.)

<b>Options</b>	
1E5	High stability timebase
1CM	Rack Kit, part number 08647-61020
0B0	Delete manual
0B1	Extra manual (includes service information)
W30	Three year warranty

<b>Translated Operating Manuals</b>	
Option AB0	Chinese for Taiwan, part number 08647-90010
Option AB1	Korean, part number 08647-90011
Option AB2	Chinese for PRC, part number 08647-90012
Option ABE	Spanish, part number 08647-90013
Option ABJ	Japanese, part number 08647-90016

<b>Accessories</b>	
Transit Case	Part number 5960-2229
Remote Interface	HP 83300A
Memory Interface	HP 83301A

---

## Regulatory Information

### ISO 9002 Compliant

The HP 8647A signal generators are manufactured in an ISO 9002 registered facility in concurrence with Hewlett-Packard's commitment to quality.

### Statement of Compliance

This instrument has been designed and tested in accordance with IEC Publication 348, Safety Requirements for Electronic Measuring Apparatus, and has been supplied in a safe condition. The instruction documentation contains information and warnings which must be followed by the user to ensure safe operation and to maintain the instrument in a safe condition.

### Noise Declaration

Notice for Germany: Noise Declaration  
LpA < 70 dB  
am Arbeitsplatz (operator position)  
normaler Betrieb (normal position)  
nach DIN 45635 T. 19 (per ISO 7779)

## Service

---

This chapter provides the procedures to troubleshoot your instrument to the assembly level. In addition to this introductory information which includes shipping instructions and an overview of the operation verification software, this chapter consists of the following three major sections.

- Chapter 5a provides the theory of operation for each major assembly and a simplified block diagram to describe the instrument's operation.
- Chapter 5b provides troubleshooting information consisting of a troubleshooting checklist, fuse replacement instructions, a diagram of modulation test points and power supply LEDs, a power supply distribution diagram, and an instrument block diagram.
- Chapter 5c lists the service error messages and gives a description of the error, and possible causes and resolutions.

---

### Warning

**These servicing instructions are for use by qualified personnel only. To avoid electrical shock, do not perform any servicing unless you are qualified to do so.**

---

### Warning

**This is a Safety Class 1 Product (provided with a protective earthing ground incorporated in the power cord.) The mains plug shall only be inserted in a socket outlet provided with a protective earth contact. Any interruption of the protective conductor inside or outside of the instrument is likely to make the instrument dangerous. Intentional interruption is prohibited.**

---



---

## Shipping Your Instrument Back to Hewlett-Packard

If it becomes necessary to ship your instrument back to HP, use the original packaging or something comparable that provides sufficient padding to protect the instrument. (See Chapter 3, "Installation," for more detailed packaging information.) Fill out a blue repair tag and attach it to the instrument. Repair tags are located at the end of this manual behind the index.

A list of HP sales and service offices is located at the front of this book on page v.

---

## **Operation Verification Software**

This software performs a quick automated verification of the HP 8647A functionality. The software uses the HP 8902A measuring receiver and HP 11722A power sensor to verify the HP 8647A level accuracy, modulation accuracy, and dc FM frequency stability. These tests supply a high degree of confidence that the HP 8647A is functioning correctly. The software is a subset of the performance tests that are described in chapter 8. For a complete calibration, all performance tests and data points described in the performance test chapter must be verified. Whenever there is any doubt about the performance of the HP 8647A, the manual performance tests should be used to resolve the issue.

This software is provided without any warranties or support. It may be copied or modified so long as it is not reproduced for sale.

The software is a large program with many compiled subroutines. The software must be run under HP BASIC 6.0 using an HP series 200 or 300 computer. The memory required for the program is approximately 6 MBytes. The HP part number for the software is 08647-10001.

## Theory of Operation

### Introduction

Use the circuit descriptions and the simplified block diagram in this chapter to understand the instrument's operation.

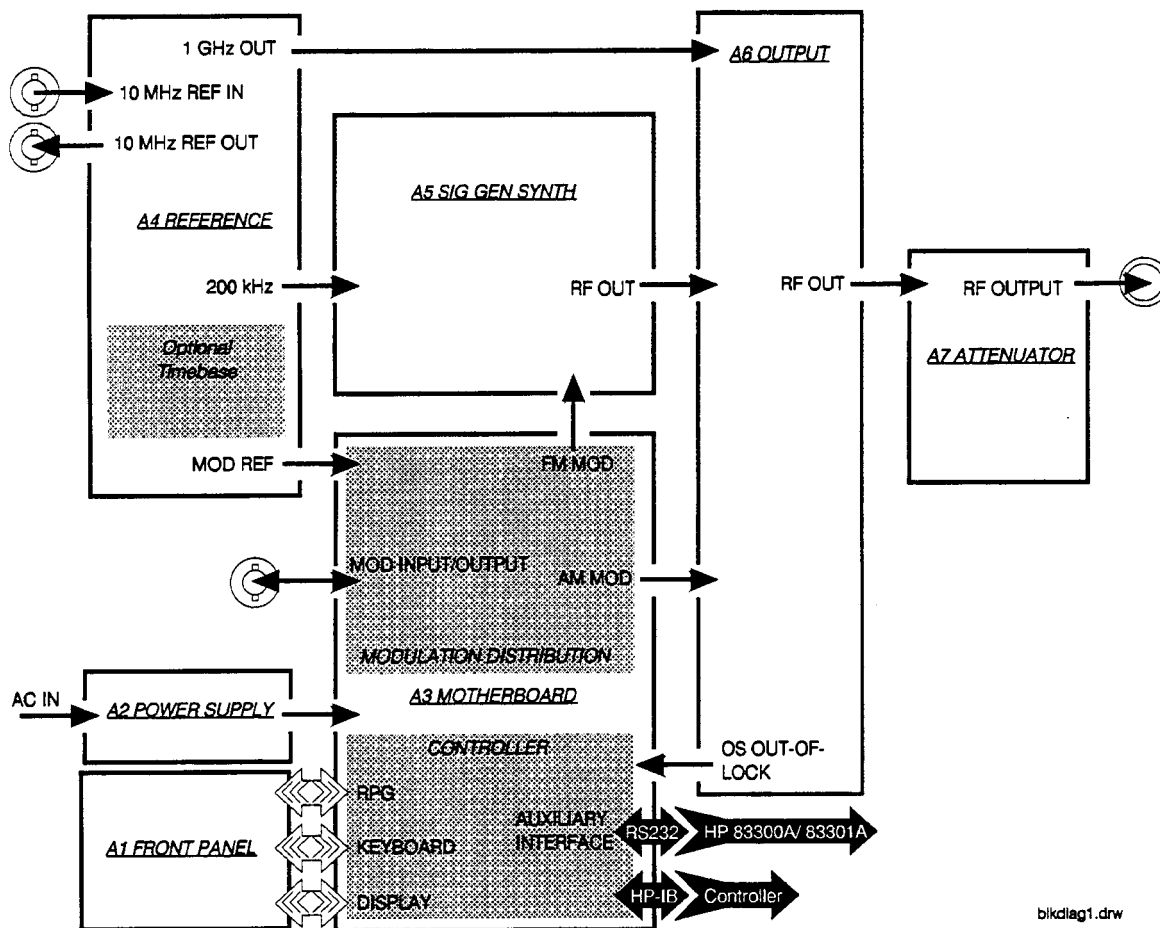

Figure 5a-1. Simplified Block Diagram

bikdiag1.drw

**Overview** The HP 8647A signal generator covers the frequency range of 0.25 to 1000 MHz in three bands. The frequency bands are:

- 0.25 to 249 MHz
- 249 to 501 MHz
- 501 to 1000 MHz

The output amplitude is from +10 to -136 dBm. The HP 8647A supports AM, FM, and phase modulation.

The possible sources are:

- Internal 400 Hz or 1 kHz source.
- External ac- or dc-coupled source.
- Internal 1 kHz plus external dc-coupled source.

**A1 Front Panel** The front panel contains two RPGs (rotary pulse generator), the keyboard, and the LCD display.

The two RPGs, one for frequency and one for amplitude, are connected directly to the controller on the A3 board. Each RPG receives power and ground from the controller. Each RPG returns two out-of-phase pulsed lines when the knob is turned.

The keyboard is a matrix of keys as shown in Table 5a-1. The keyboard is scanned by the controller. Scanning pulses are sent alternately to the keyboard rows and are read back on the columns when a key is pressed. The controller determines which key was pressed based on the row that was pulsed and the column that the signal was returned on. The column lines are pulled-up through resistors and are pulsed low when a key is pressed. The row output latches are open-collector, therefore, pulses can not be seen until the circuit is completed by pressing a key. The keyboard connects directly to the controller at A3J3.

The display is driven by the controller through data latches on the A3 assembly. The display control lines are eight bi-directional data lines, an enable clock line, a read/write line, and a data/instruction line. The other lines going to the display are the backlight +5 V and ground, display +5 V and ground, and the contrast control. The enable clock line is high during every data interchange. The read/write line is high for a read operation and low for a write operation. The data/instruction line is high for a data operation and low for an instruction operation. The data/instruction line is used only during write operations. Data refers to the character data while instruction refers to commands, such as return or space. When interchanging data, the controller polls the display for acknowledgement. This means that if the display is disconnected the controller will cease to attempt operations.

**Table 5a-1. A1 Front Panel (keyboard)**

	Col 1 A3J3-1	Col 2 A3J3-2	Col 3 A3J3-3	Col 4 A3J3-4	Col 5 A3J3-5	Col 6 A3J3-6	Col 7 A3J3-7
Row 1 A3J3-9	⇐ (freq)	FREQUENCY	INCR SET	7	8	9	MHz dB(m)
Row 2 A3J3-10	⇒ (freq)	AMPLITUDE	↑	4	5	6	kHz mV
Row 3 A3J3-11	REF SET (freq)	FM	↓	1	2	3	% μV
Row 4 A3J3-12	REF ON/OFF (freq)	AM	ϕM	0	.	±	rad dBμV
Row 5 A3J3-13	ADRS	SAV	REG	↑ (memory)	MOD ON/OFF	INT 400 Hz	EXT AC
Row 6 A3J3-14	LOCAL	DEL	SEQ	↓ (memory)	1 kHz + EXT DC	INT 1 kHz	EXT DC
Row 7 A3J3-15	⇐ (ampl)	⇒ (ampl)	REF SET (ampl)	REF ON/OFF (ampl)	RF ON/OFF	ATTN HOLD	
Row 8 A3J3-16	← (back space)	mV emf	μV emf	dBμV emf			

## A2 Power Supply

The power supply is a switching power supply producing 4 voltages; +5 V, +15 V, -15 V, and +38 V. The switching supply will only regulate when connected to a load. The power supply receives mains (line) voltage through the power switch on the front panel and the line module on the rear panel. Post regulation on the A3 assembly produces ±12 V, filtered +5 V, and +5 V.

## A3 Motherboard

The motherboard contains four functional blocks: modulation distribution, controller, post regulation, and diagnostic latching.

The modulation distribution block produces two level-calibrated modulation frequencies, 1 kHz and 400 Hz. The frequencies are derived by dividing a 200 kHz signal from the A4 reference module by 200 and 250. The internal signals are leveled by an amplifier and a 12-bit DAC. The signals are then routed to the A5 sig gen synth when FM is enabled, or to the A6 output for AM.

When internal modulation is turned on, the signal is also routed to the front panel MOD INPUT/OUTPUT connector. External modulation signals are also routed through the modulation distribution block. External signals can be either ac- or dc-coupled. The modulation signals can be checked at A3TP1 for the FM signal and at A3TP2 for the AM signal.

The controller contains the microprocessor, memory, serial I/O for the other assemblies, HP-IB, front-panel control, and serial interface for the external control options. Memory is broken into four sections; EEPROMs, ROM, volatile SRAM and non-volatile battery-backed SRAM. The ROMs are contained on a separate memory board, A3A1.



The post regulating circuitry contains regulators for +12V, -12V and +5 V (shown as +5V(F1)). There is additional circuitry to derive a filtered +5 V from the power supply +5 V for the digital circuitry. The +12 and +5 V regulators are driven by the +15 V supply from the A2 assembly. The -12 V regulator is driven by the -15 V supply from the A2 assembly. There are indication LEDs on the motherboard for the five power supplies that are lit when the power supplies are on.

The diagnostic latches latch signals from around the instrument that are read by the controller during power-up.

#### **A4 Reference**

The reference assembly accepts either an external 10 MHz reference signal to lock the internal 10 MHz TCXO (temperature-compensated crystal oscillator) or uses an optional high stability 10 MHz OCXO (oven-controlled crystal oscillator). The reference assembly outputs two 200 kHz signals, a 1 GHz signal, and a 10 MHz signal which is routed to the rear panel.

One of the two 200 kHz signals is routed to the A5 synthesizer and the other to the A3 modulation section. The 1 GHz signal is routed to the A6 output assembly.

The 10 MHz REF OUTPUT rear-panel signal is a buffered output from the 10 MHz TCXO or OCXO.

The 200 kHz signals are derived by dividing the 10 MHz signal by 50. The 1 GHz signal is derived from a 1 GHz VCO that is phase-locked to the 10 MHz signal.

The reference assembly contains a calibration ROM that contains factory-generated calibration data that is specific to the assembly.

#### **A5 Sig Gen Synth**

The synthesizer assembly uses a 200 kHz reference signal from the A4 reference assembly and generates a 500 to 1000 MHz signal using a divide-by-n phase-locked loop VCO. Frequency and phase modulation are also done in the synthesizer assembly. The frequency is modulated both inside and outside of the loop bandwidth. FM outside of the loop bandwidth is summed with the integrator error voltage and applied directly to the VCO. FM within the loop bandwidth and phase modulation signals are applied to a phase modulator along with the signal from the divide-by-n circuitry and then applied to the phase detector.

The synthesizer assembly contains a calibration ROM that contains factory-generated calibration data that is specific to the assembly.

#### **A6 Output**

The output assembly takes the 500 to 1000 MHz signal from the A5 assembly and the 1 GHz LO signal from the A4 assembly to generate the output frequency range of 0.25 to 1000 MHz in three bands. The output assembly also handles the filtering, AM, and amplitude leveling functions.

The three frequency bands range from 0.25 to 249 MHz, 249 to 501 MHz, and 501 to 1000 MHz. The 0.25 to 250 MHz band is heterodyned from the 1 GHz LO signal and the 500 to 1000 MHz main band signal.

The 250 to 500 MHz signal is derived by dividing the 500 to 1000 MHz main band signal by two.

Filtering is handled by separate low-pass filters for each frequency band.

AM is done using two separate modulators, one for the divide band and one dual-output modulator for the main and heterodyne bands. The AM signal from the A3 modulation section for both modulators is summed into the ALC loop integrator.

Amplitude leveling is handled with an ALC loop to lock the level and an amplitude DAC to set the level. The error signal from the ALC integrator is sent to either of the two modulators along with the summed AM signal.

The output assembly contains a calibration ROM that contains factory-generated calibration data that is specific to the assembly.

## **A7 Attenuator**

The attenuator assembly contains the attenuators, the reverse-power-protection circuitry and the temperature-sense circuitry.

The attenuator assembly contains a calibration ROM that contains factory-generated calibration data that is specific to the assembly.

## Troubleshooting Information

---

### Introduction

This chapter is intended to be used in conjunction with the information in chapters 5a, 5c, and with your own troubleshooting style. The troubleshooting reference information should contain the details needed as you follow your troubleshooting process.

This chapter contains the following troubleshooting reference information.

- Troubleshooting Checklist

Use the troubleshooting checklist as a reminder of things to check.

- AC Mains (Line) Fuse Removal

Use these instructions to replace the AC mains fuse.

- Modulation Test Points and Power Supply LEDs Diagram

Use the diagram to check for the proper modulation reading and for a quick visual check that the power supply voltages are present.

- Power Supply Distribution Diagram

Use the diagram to identify the correct power supply voltage distribution.

- Instrument Block Diagram

The block diagram contains pin and connector designations as well as input/output specifications.

See Chapter 5a, "Theory of Operation," for the block diagram description.

### Warning

---

**The opening of covers or removal of parts is likely to expose dangerous voltages. Disconnect the instrument from all voltage sources while it is being opened.**

**The power cord is connected to internal capacitors that may remain live for 5 seconds after disconnecting the plug from its power supply.**

---

# Troubleshooting Checklist

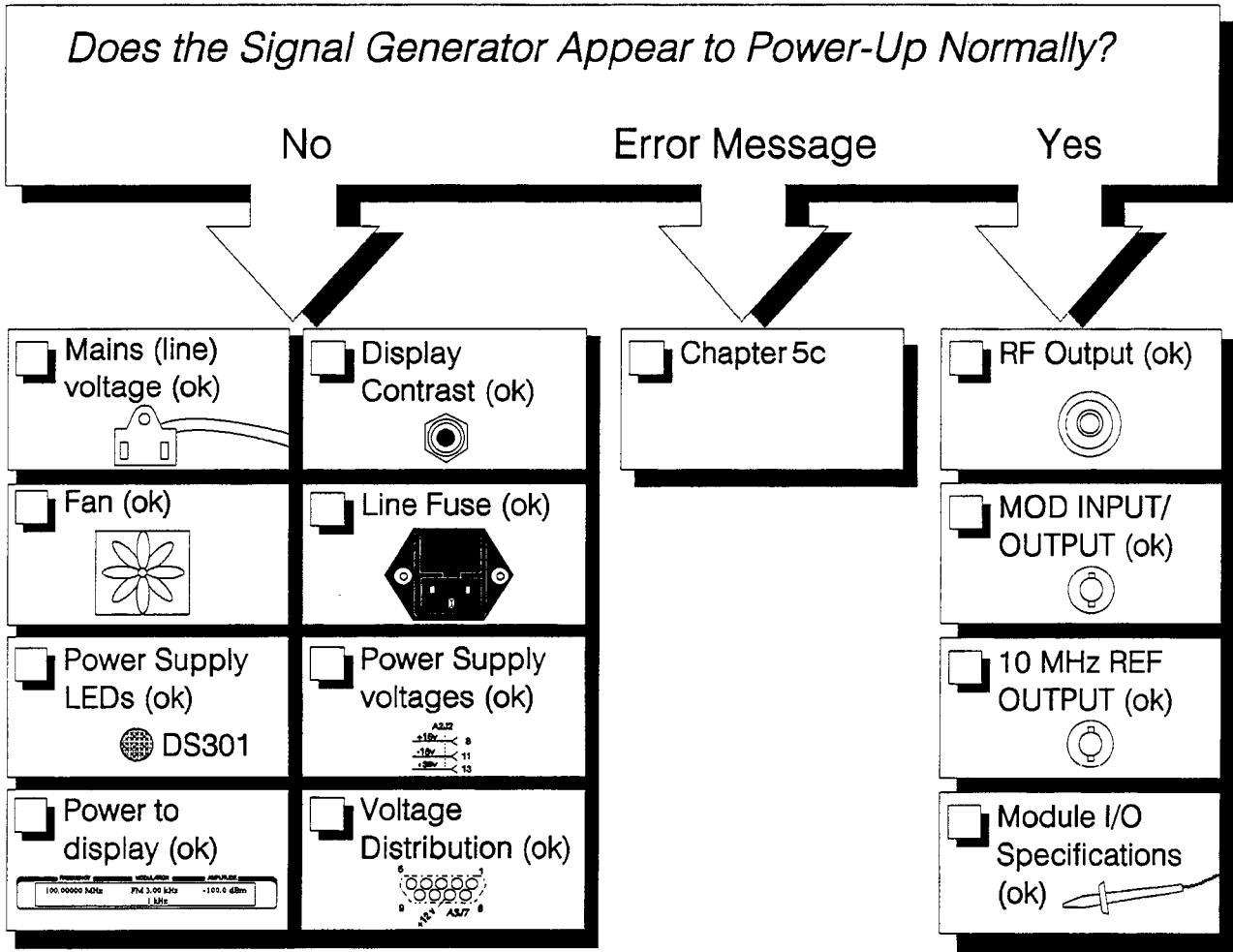

chklist\_c.tif

---

## AC Mains (line) Fuse Removal

### To Remove the Fuse

1. Unplug the power cord from the mains (line) module.
2. Use a flat-bladed screw driver (Figure 5b-1) to pry and unseat the fuse housing from the line module.
3. Remove the cartridge and inspect the fuse nearest the front of the instrument.

### Warning

---

**For continued protection against fire hazard, replace the fuse only with the same type and ratings, (3A 250 V type F.) The use of other fuses or materials is prohibited.**

---

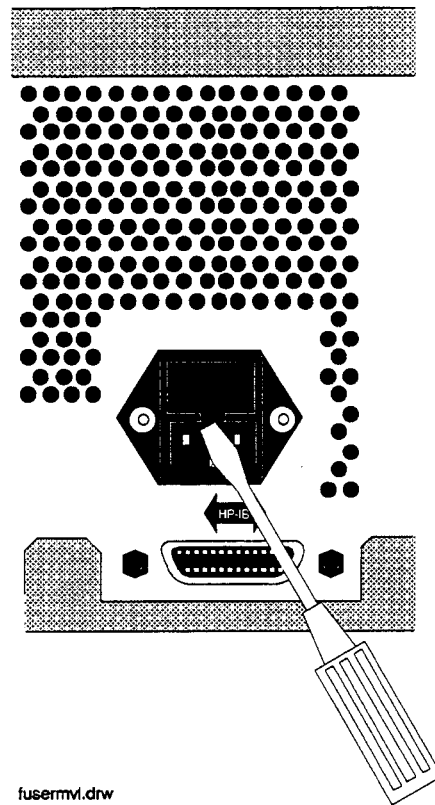

**Figure 5b-1. Removing the Fuse Housing**

# Modulation Testpoints and Power Supply LEDs

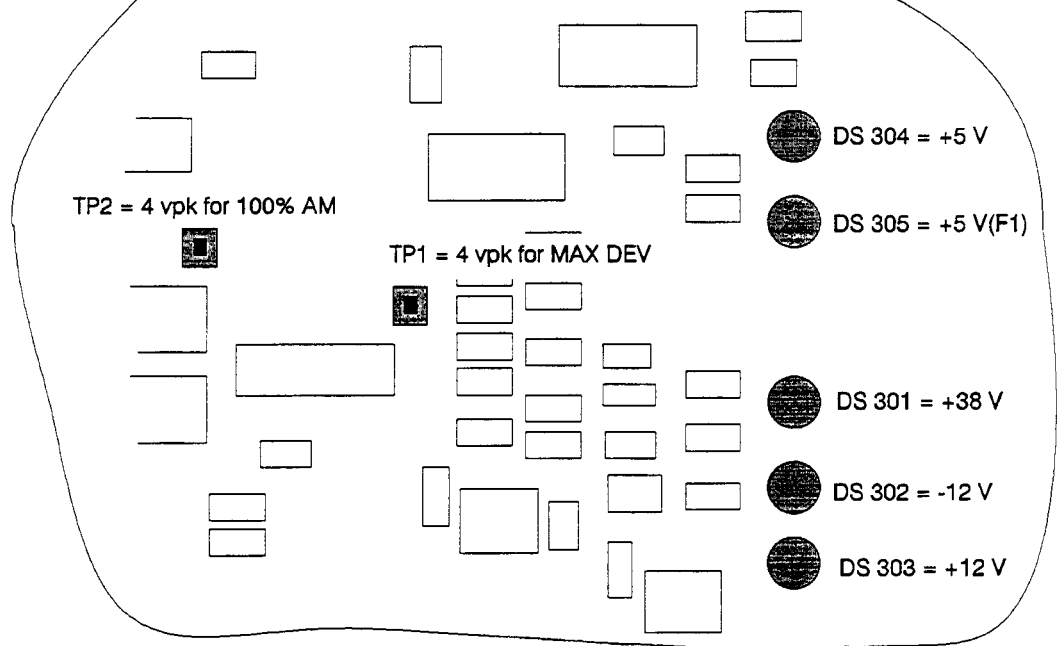
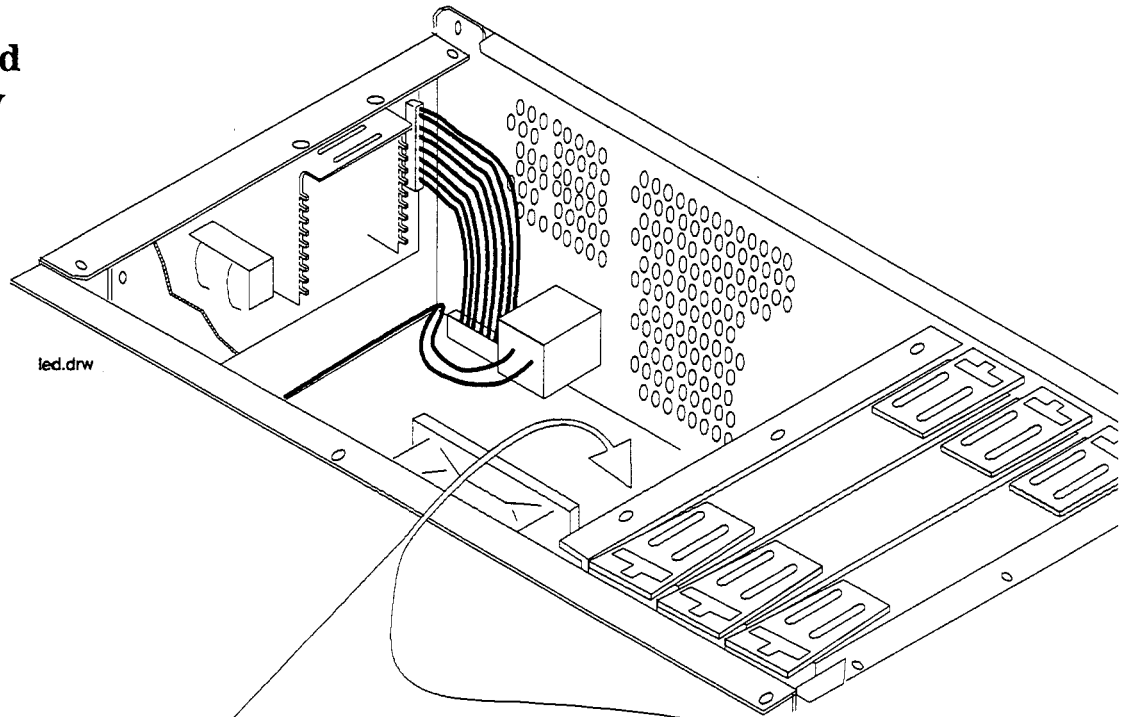

**Location Diagram**



## Service Error Messages

---

This chapter describes service error messages. Front panel and HP-IB operation messages are covered in Chapter 1c, "Operation Messages".

502	Updated cal file
Description	The RAM calibration file has been updated from the calibration ROM.
Cause	This is normal when a module is replaced.
What To Do	This message requires no action.
503	Cal corrupt: restored
Description	After detecting a failure in comparing calibration data between RAM and the calibration ROM, a data restore was done.
What To Do	This message requires no action.
504	Modulation cal restore failure
Description	After detecting a failure comparing calibration data between RAM and the calibration ROM, a data restore was attempted unsuccessfully.
Cause	There is either a failure in writing data to RAM or in reading data from the calibration ROM.
What To Do	Replace the A3 assembly. Both the calibration ROM and RAM are on the A3 assembly.
505	FM sense cal restore failure
Description	After detecting a failure in comparing calibration data between RAM and the calibration ROM, a data restore was attempted unsuccessfully.
Cause	There is either a failure in writing data to RAM or in reading data from the calibration ROM.
What To Do	The calibration ROM can be verified by replacing the A5 assembly. The calibration ROM is contained in the assembly.  If the failure is still present after replacing the A5 assembly, replace the A3 assembly, which contains the RAM.



506	FM mult cal restore failure
Description	After detecting a failure in comparing calibration data between RAM and the calibration ROM, a data restore was attempted unsuccessfully.
Cause	There is either a failure in writing data to RAM or in reading data from the calibration ROM.
What To Do	The calibration ROM can be verified by replacing the A5 assembly. The calibration ROM is contained in the assembly.  If the failure is still present after replacing the A5 assembly, replace the A3 assembly, which contains the RAM.
507	Output level cal restore failure
Description	After detecting a failure in comparing calibration data between RAM and the calibration ROM, a data restore was attempted unsuccessfully.
Cause	There is either a failure in writing data to RAM or in reading data from the calibration ROM.
What To Do	The calibration ROM can be verified by replacing the A6 assembly. The calibration ROM is contained in the assembly.  If the failure is still present after replacing the A6 assembly, replace the A3 assembly, which contains the RAM.
508	Attenuator cal restore failure
Description	After detecting a failure in comparing calibration data between RAM and the calibration ROM, a data restore was attempted unsuccessfully.
Cause	There is either a failure in writing data to RAM or in reading data from the calibration ROM.
What To Do	The calibration ROM can be verified by replacing the A7 assembly. The calibration ROM is contained in the assembly.  If the failure is still present after replacing the A7 assembly, replace the A3 assembly, which contains the RAM.

509	<b>Timebase cal restore failure</b>
Description	After detecting a failure in comparing calibration data between RAM and the calibration ROM, a data restore was attempted unsuccessfully.
Cause	There is either a failure in writing data to RAM or in reading data from the calibration ROM.
What To Do	The calibration ROM can be verified by replacing the A4 assembly. The calibration ROM is contained in the module.  If the failure is still present after replacing the A4 assembly, replace the A3 assembly, which contains the RAM.
510	<b>Temperature cal restore failure</b>
Description	After detecting a failure in comparing calibration data between RAM and the calibration ROM, a data restore was attempted unsuccessfully.
Cause	There is either a failure in writing data to RAM or in restoring data from the calibration ROM.
What To Do	The calibration ROM can be verified by replacing the A7 assembly. The calibration ROM is contained in the module.  If the failure is still present after replacing the A7 assembly, replace the A3 assembly, which contains the RAM.
511	<b>TC coeff's cal restore failure</b>
Description	After detecting a failure in comparing calibration data between RAM and the calibration ROM, a data restore was attempted unsuccessfully.
Cause	There is either a failure in writing data to RAM or in reading data from the calibration ROM.
What To Do	The calibration ROM can be verified by replacing the A7 assembly. The calibration ROM is contained in the assembly.  If the failure is still present after replacing the A7 assembly, replace the A3 assembly, which contains the RAM.

512	Generic path cal restore failure
Description	After detecting a failure in comparing calibration data between RAM and the calibration ROM, a data restore was attempted unsuccessfully.
Cause	There is either a failure in writing data to RAM or in reading data from the calibration ROM.
What To Do	Replace the A3 assembly. The A3 assembly has a continuity failure. The calibration ROM is on the A3 assembly with the RAM.
513	Output tune cal restore failure
Description	After detecting a failure in comparing calibration data between RAM and the calibration ROM, a data restore was attempted unsuccessfully.
Cause	There is either a failure in writing data to RAM or in reading data from the calibration ROM.
What To Do	The calibration ROM can be verified by replacing the A6 assembly. The calibration ROM is contained in the assembly.  If the failure is still present after replacing the A6 assembly, replace the A3 assembly, which contains the RAM.
601	-12 V power supply failure
Description	The -12 V diagnostic test point decreased by more than approximately 0.4 V.
Cause	Either the -12 V regulator on the A3 mother board has failed, or the -15 V supply on the A2 power supply assembly has failed.
What To Do	Check the output of both the -15 V and -12 V supplies.
603	+12 V power supply failure
Description	The +12 V diagnostic test point decreased by more than approximately 0.4 V.
Cause	Either the +12 V regulator on the A3 mother board has failed, or the +15 V supply on the A2 power supply assembly has failed.
What To Do	Check the output of both the +15 V and +12 V supplies.

604	<b>+38 V power supply failure</b>
Description	The +38 V diagnostic test point decreased by more than approximately 2.2 V.
Cause	The +38 V supply on the A2 power supply has failed.
What To Do	Check the +38 V supply.
605	<b>ALC out-of-lock div het main band</b>
Description	The ALC loop is out of lock in the indicated bands.
Cause	Either the A6 output has failed, or the signal from the A5 synthesizer has failed or the A4 reference has failed. If only the het band has failed it is possible that the A4 reference has failed.
What To Do	Check the input to the A6 output from the A5 synthesizer and the A4 reference.
608	<b>Synth out-of-lock div het main band</b>
Description	The synthesis loop is out of lock in the indicated bands.
Cause	Either the A5 synthesizer has failed, or the signal from the A4 reference has failed.
What To Do	Check the input to the A5 synthesizer from the A4 reference.
611	<b>200 kHz reference missing at synth</b>
Description	The A5 module indicates that the 200 kHz reference signal from the A4 module is not being detected.
Cause	Either the A4 module has failed to output the 200 kHz reference signal, or the A5 module is failing to detect the signal.
What To Do	Check the 200 kHz reference output of the A4 module at the input to the A5 module.
612	<b>Reference out-of-lock at 10 MHz</b>
Description	The A4 module indicates that the 10 MHz reference VCO is out-of-lock.
Cause	Either the A4 module has failed or a bad external reference is connected.
What To Do	Disconnect any external reference and power-up the instrument again or replace the A4 module if the error is still present with no external reference.

613	Reference out-of-lock at 1 GHz
Description	The A4 module indicates that the 1 GHz reference is out-of-lock.
Cause	Either the A4 module has failed or a bad external reference is connected.
What To Do	Replace the A4 module.
614	400 Hz modulation source failed
Description	The A3 board indicates that the 400 Hz modulation source is not present.
Cause	Either the 200 kHz reference signal from the A4 module has failed, or the A3 has failed.
What To Do	Check the 200 kHz reference output of the A4 module at the input to the A3 board.
615	1 kHz modulation source failed
Description	The A3 board indicates that the 1 kHz modulation source is not present.
Cause	Either the 200 kHz reference signal from the A4 modulation source has failed, or the A3 board has failed. However, if the 400 Hz modulation source has already been tested, the failure is most likely the A3 board.
What To Do	Replace the A3 board.
616	AM modulation path failure
Description	The AM path detector indicates a failure at the output of the A3 board.
Cause	Either the signal output has failed, or the detector has failed.
What to Do	Replace the A3 board
617	FM modulation path failure
Description	The FM path detector indicates a failure at the output of the A3 board.
Cause	Either the signal output has failed, or the detector has failed.
What To Do	Replace the A3 board.

618	PM modulation path failure
Description	The PM path detector indicates a failure at the output of the A3 board.
Cause	Either the signal output has failed, or the detector has failed.
What To Do	Replace the A3 board.
619	Modulation 20 dB step failure
Description	The 20 dB step attenuator has failed.
Cause	The A3 board has failed.
What To Do	Replace the A3 board.
620	Comm failure:
Description	A serial communication failure has occurred with the indicated assemblies.
Cause	Either the A3 controller has failed or the indicated assembly has failed.
What To Do	If one assembly has failed, check the indicated assembly. If multiple failures have occurred, check the controller first. In either case, both the controller and the assembly should be checked.
625	ROM checksum failure
Description	The A3 controller has detected a mismatch in reading data from ROM.
Cause	Either the controller has failed in reading from ROM, or the ROM data has failed.
What To Do	Check the hardware connection between the mother board and the ROM board.
626	Volatile RAM read/write failure
Description	The controller detected a failure when comparing data that was written to, and then read from volatile RAM.
Cause	This is a hardware failure between points on the A3 board.
What To Do	The A3 board failure should be verified and the board replaced.

627	Battery RAM failure: memory lost
Description	The battery-backed RAM lost data.
Cause	Either the RAM has failed, the battery is bad, or the <b>DEL</b> key was held down at power-up.
What To Do	Check the battery voltage and replace if it is incorrect.
628	Non-volatile RAM read/write failure
Description	The controller detected a failure when comparing data that was written to, and then from non-volatile RAM.
Cause	This is a hardware failure between points on the A3 board.
What To Do	The A3 board failure should be verified and the board replaced.

# Replaceable Parts

## Introduction

To order parts, contact your local Hewlett-Packard sales and service office. A list of the offices is given on page v, at the front of this book. In the U.S.A. it is also possible to call 800-227-8164 and they will take your parts order. If you need help finding the correct part number, you can call HP Parts Identification at 916-783-0804 in the U.S.A.

## Assembly Replacements

For most parts, you can either order a new assembly or an exchange assembly. Exchange assemblies are factory repaired, inspected, and tested. If you order an exchange assembly you must return the defective assembly part.

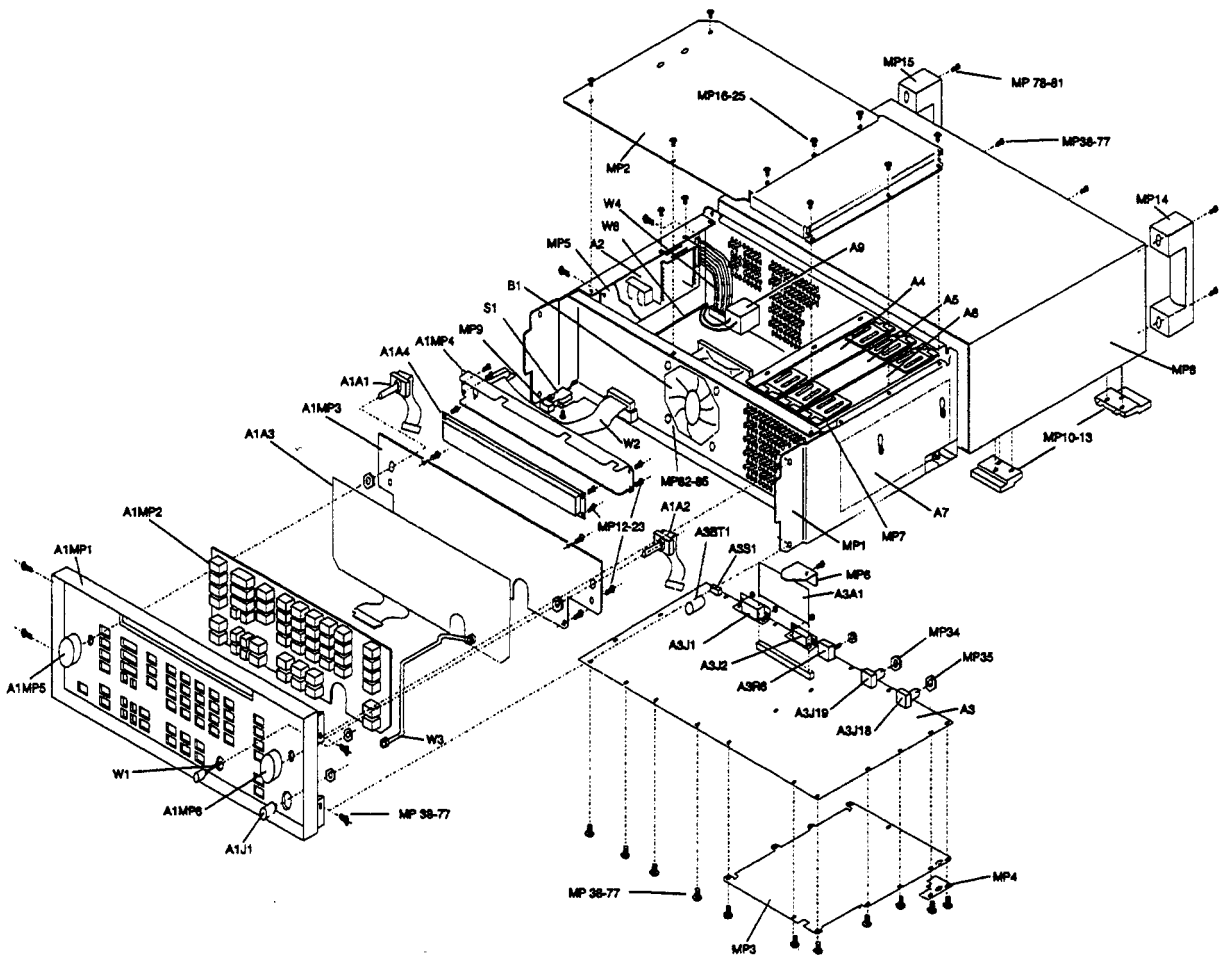

exview\_c.tif



**Table 6-1. Replaceable Parts**

Item	HP Part Number	Qty.	Description
A1		1	AY-FRONT FRAME (NOT AVAILABLE FOR REPLACEMENT)
A1A1	0960-0856	1	RPG
A1A2	0960-0856	1	RPG
A1A3	08647-61008	1	FLEX CIRCUIT
A1A4	2090-0312	1	DISPLAY LCD 2X40
A1J1	1250-1811	1	RF OUTPUT TYPE-N CONNECTOR
A1MP1	08647-61810	1	FRONT & FRAME ASSEMBLY
	8160-0520	1	RFI ROUND STRIP (PART OF A1MP1)
A1MP2	08647-40008	1	KEYPAD
A1MP3	08647-00004	1	DISPLAY MOUNT
A1MP4	08647-00019	1	COVER DISPLAY
A1MP5	01650-47401	1	KNOB-CURSOR
A1MP6	01650-47401	1	KNOB-CURSOR
A2	0950-2293	1	POWER SUPPLY
A3	08647-61811	1	MOTHER BD KIT
	08647-69811	1	EXCHANGE MOTHER BD KIT
A3A1	08647-61814	1	MEMORY BOARD (FIRMWARE UPGRADE KIT)
A3BT1	1420-0338	1	BATTERY 3.0V 1.2AH
A3J1	1252-2161	1	CONNECTOR RECT24F
A3J2	1252-1487	1	CONNECTOR RECT 9 F RA
A3J18	1250-1842	1	10 MHZ INPUT BNC
A3J19	1250-1842	1	10 MHZ OUTPUT BNC
A3R6	2100-4507	1	CONTRAST POTENTIOMETER
A3S1	3101-2264	1	TIMEBASE ADJ SWITCH
A4	08647-61845	1	STANDARD REFERENCE KIT
	08647-69045	1	STANDARD EXCHANGE REF KIT
	08920-40009	2	CAM LEVERS (P/O A4)
	08920-40016	2	LEVER LOCKS (P/O A4)
A4	08647-61846	1	OPT 001 HIGH STABILITY REFERENCE KIT
	08647-69046	1	EXCHANGE OPT 001 HIGH STAB REF KIT
A5	08647-61847	1	SIG GEN SYNTH KIT
	08647-69047	1	EXCHANGE SIG GEN SYNTH KIT
	08920-40009	2	CAM LEVERS (P/O A5)
	08920-40016	2	LEVER LOCKS (P/O A5)

**Table 6-1. Replaceable Parts (continued)**

Item	HP Part Number	Qty.	Description
A6	08647-61848	1	OUTPUT ASSY KIT
	08647-69048	1	EXCHANGE OUTPUT ASSY KIT
	08920-40009	2	CAM LEVERS (P/O A6)
	08920-40016		LEVER LOCKS (P/O A6)
A7	08647-61803	1	ATTEN KIT
	08647-69803	1	EXCHANGE ATTEN KIT
A9	9135-0270	1	FILTERED LINE MOD
	0361-1265	2	RIVETS (HOLDS A9 TO MP1)
B1	3160-0597	1	FAN TBAX 48CFM
F1	2110-0780	1	FUSE 3 A 250 V (NOT SHOWN)
MP1	08647-61002	1	ASSEMBLY CHASSIS
MP2	08647-00007	1	COVER CARDBOX
MP3	08647-00006	1	COVER-MOTHER BOARD
MP4	08647-00013	1	COVER RF
MP5	08647-00020	1	MOUNT-POWER SUPPLY
MP6	08647-00018	1	CLAMP (MEMORY BOARD BRACKET)
MP7	08647-00018	1	CLAMP (CABLE BRACKET)
MP8	08647-00005	1	COVER-INSTRUMENT
MP9	5041-3621	1	LINE SWITCH KEY CAP
MP10-13	5041-8801	4	FOOT FULL MOD
MP12-23	0515-0383	12	SCREW MACHINE ASSEMBLY M4 X 0.7 16MM-LG
MP14-15	08647-40003	2	REAR FOOT HANDLE
MP16-25	0515-0380	10	SCREW MACH. 4.0 10SEMPAN TX
MP34-35	2950-0054	2	NUT HEX 1/2 - 28
MP38-77	0515-0380	35	SCREW MACH. 4.0 10SEMPAN TX
MP78-81	0515-0383	4	SCREW MACHINE ASSEMBLY M4 X 0.7 16MM-LG
MP82-85	0361-1341	4	RIVET NYL 3.9DIA (HOLDS B1 TO MP1)
S1	3101-2216	1	LINE SWITCH
	0515-1940	2	SCREW MACH 2.5 6PCHPANTX (P/O S1)
W1	08647-61007	1	MODULATION CABLE
W2	08647-61011	1	DISPLAY CABLE
W3	08647-61021	1	RF OUTPUT CABLE
W4	08647-61005	1	POWER SUPPLY CABLE
W5			(NOT ASSIGNED)
W6	08647-61004	1	ASSY INCLUDES [LINE SWITCH (S1) AND WIRE HARNESS AND LINE MODULE (A9)]
Miscellaneous Accessory	08647-90018	1	TRANSIT CASE

## Adjustments

---

### Internal Timebase Adjustment

Use this procedure to adjust the internal timebase reference DACs. The internal reference oscillator is adjusted with two DACs, one for coarse tuning and one for fine tuning. Using the two DACs the internal reference oscillator can be adjusted to the resolution of the frequency counter used.

#### Recommended Equipment (or equivalent)

- HP 5316B Frequency Counter
- HP 5065 Frequency Standard

#### Procedure

- Turn the signal generator (UUT) off.
- Set the rear panel timebase adjust switch to on (1).
- Turn the signal generator on and wait for the “5 second self test” to finish.
- Connect the equipment as shown.
- Follow the instructions on the signal generator’s display and adjust the knobs until the counter reads exactly 10,000,000 MHz.
- When the adjustment is complete turn the signal generator off.
- Set the rear panel Timebase Adjust switch to off (0).

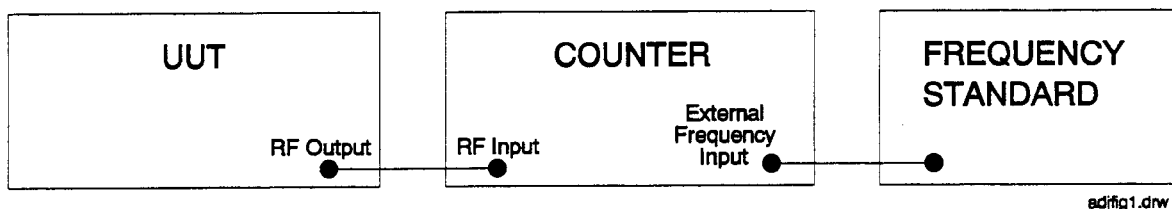

Internal Timebase Adjustment Setup

## Performance Tests

---

The procedures in this chapter test the electrical performance of the signal generator. These tests do not require access to the interior of the instrument.

This chapter contains the following information:

<b>Required Test Equipment List</b>	A list of all the equipment required to perform these tests.
<b>Performance Tests</b>	The performance tests required to verify the signal generator to its specifications.
<b>Test Records</b>	A test record to record the results of the tests is located at the end of this chapter. Keep the test record as a master and use a photocopy for each calibration.

See Chapter 4, "Specifications," for the specifications for the signal generator.

---

## Calibration Cycle

This instrument requires periodic verification of performance. Under normal use and environmental conditions, an instrument should be calibrated every 2 years. Normal use is defined to be about 2,000 hours of use per year.

---

## Required Test Equipment

- HP 8903B (Option 051) Audio Analyzer
  - Distortion Accuracy:  $\pm 1$  dB
  - Residual distortion:  $-80$  dB at 80 kHz BW
  - 30 kHz low-pass filter
  - AC level accuracy:  $\pm 4\%$
  - CCITT weighting filter
- HP 8902A Measuring Receiver
  - FM accuracy:  $\pm 2\%$  of reading  $\pm 1$  digit
  - AM accuracy:  $\pm 2\%$  of reading  $\pm 1$  digit
  - Frequency accuracy:  $\pm 35$  Hz at 1000 MHz (includes reference accuracy and counter accuracy)
  - Range: 250 kHz to 1000 MHz
  - Filters: 300 Hz high-pass; 15 kHz low-pass
  - Detectors: Peak +

### Note

---

For the RF level accuracy performance test, the HP 8902A with a HP 11722A sensor is required. (No other equipment substitutions are allowed for this test.)

---

- HP 8566B RF Spectrum Analyzer
  - Frequency range: 1 MHz to 2000 MHz
  - Relative level accuracy:  $\pm 2$  dB
- HP 11722A Sensor Module

## FM Accuracy Performance Test

### Connect the Test Equipment

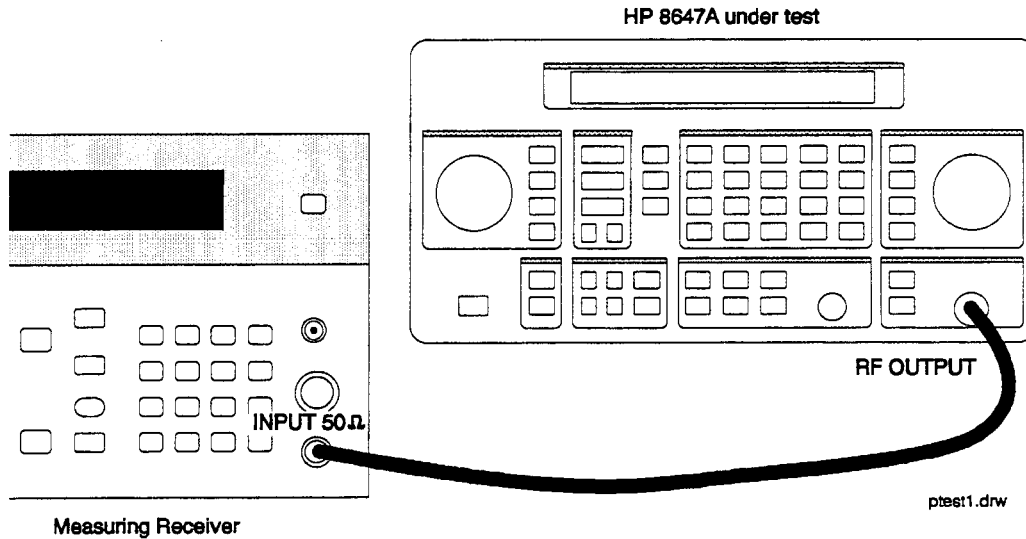

Figure 8-1. FM Accuracy Equipment Setup

#### Configure the Measuring Receiver

1. Reset
2. FM mode
3. Peak + detector
4. 300 Hz high-pass filter
5. 15 kHz low-pass filter

#### Configure the HP 8647A

1. Turn FM on; press **FM** **MOD ON/OFF**.
2. Set the rate; press **INT 1 kHz**.
3. Set the amplitude; press **AMPLITUDE** **4** **dB(M)**.
4. Turn the RF output on; press **RF ON/OFF**.

#### Measure Deviations

1. Enter the frequencies and deviations shown in the test record.
2. Record the test results and compare the results to the limits in the test record.

# FM Distortion Performance Test

## Connect the Test Equipment

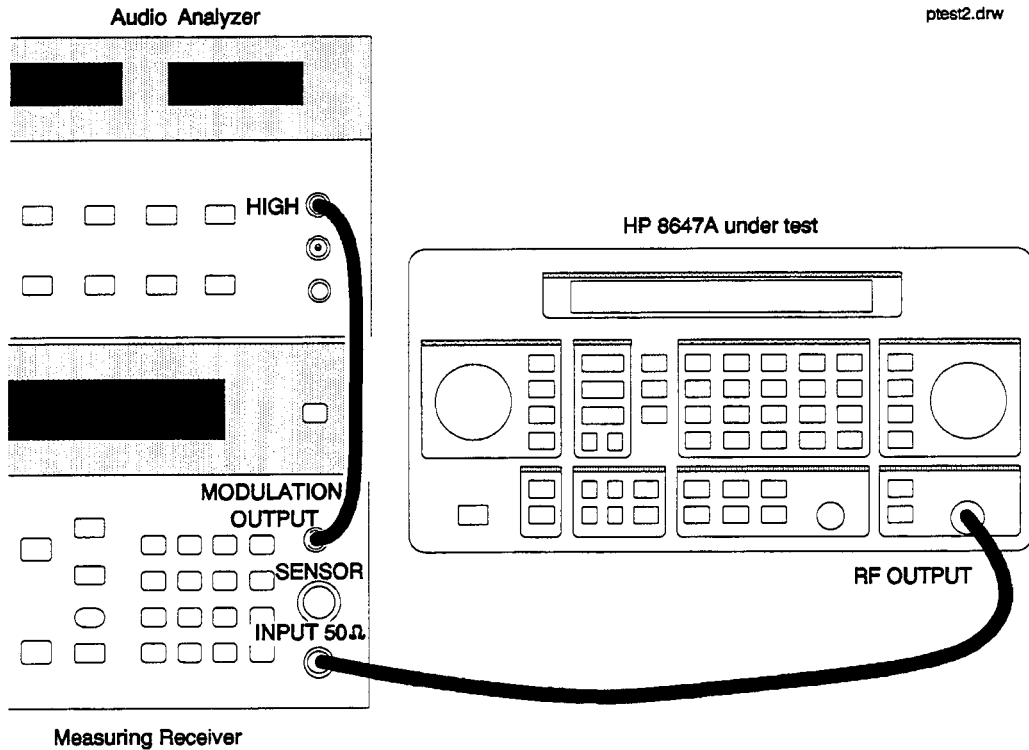

Figure 8-2. FM Distortion Equipment Setup

### Configure the Measuring Receiver

1. Reset
2. FM mode
3. Peak + detector
4. 300 Hz high-pass filter
5. 15 kHz low-pass filter

### Configure the Audio Analyzer

1. Distortion mode
2. 30 kHz low-pass filter

## FM Distortion Performance Test

### Configure the HP 8647A

1. Turn FM on; press **FM** **MOD ON/OFF**.
2. Set the rate; press **INT 1 kHz**.
3. Set the amplitude; press **AMPLITUDE** **4** **dBm**.
4. Turn the RF output on; press **RF ON/OFF**.

### Measure Distortion

1. Enter the frequencies and deviations shown in the test record.
2. Record the test results and compare the results with the limits in the test record.



## AM Accuracy Performance Test

### Connect the Test Equipment

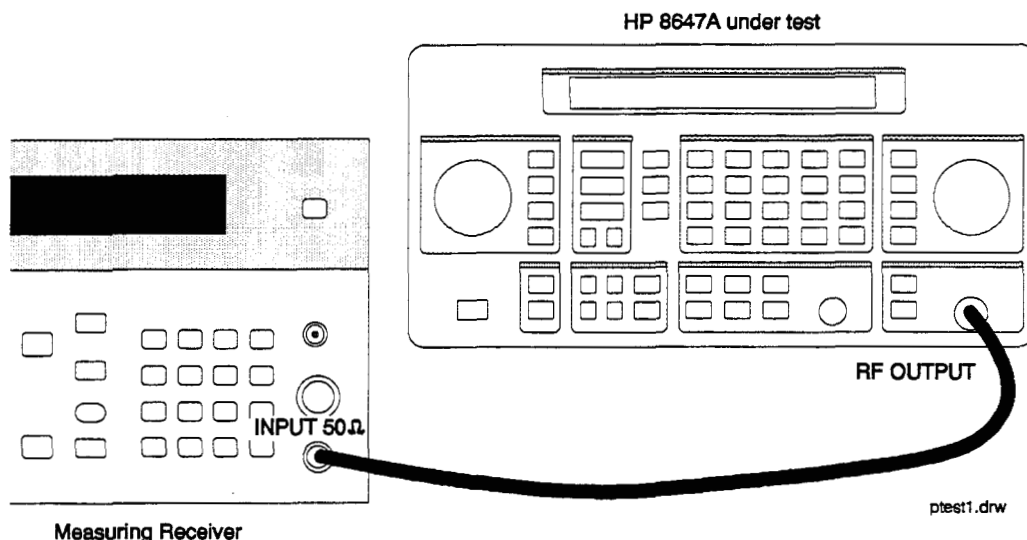

Figure 8-3. AM Accuracy Equipment Setup

#### Configure the Measuring Receiver

1. Reset
2. AM mode
3. Peak+ detector
4. 300 Hz high-pass filter
5. 15 kHz low-pass filter

#### Configure the HP 8647A

1. Turn AM on; press **AM** **MOD ON/OFF**.
2. Set the rate; press **INT 1 kHz**.
3. Turn the RF output on; press **RF ON/OFF**.

#### Measure Depths

1. Enter the amplitudes, frequencies and depths shown in the test record.
2. Record the test results and compare the results to the limits in the test record.

# AM Distortion Performance Test

## Connect the Test Equipment

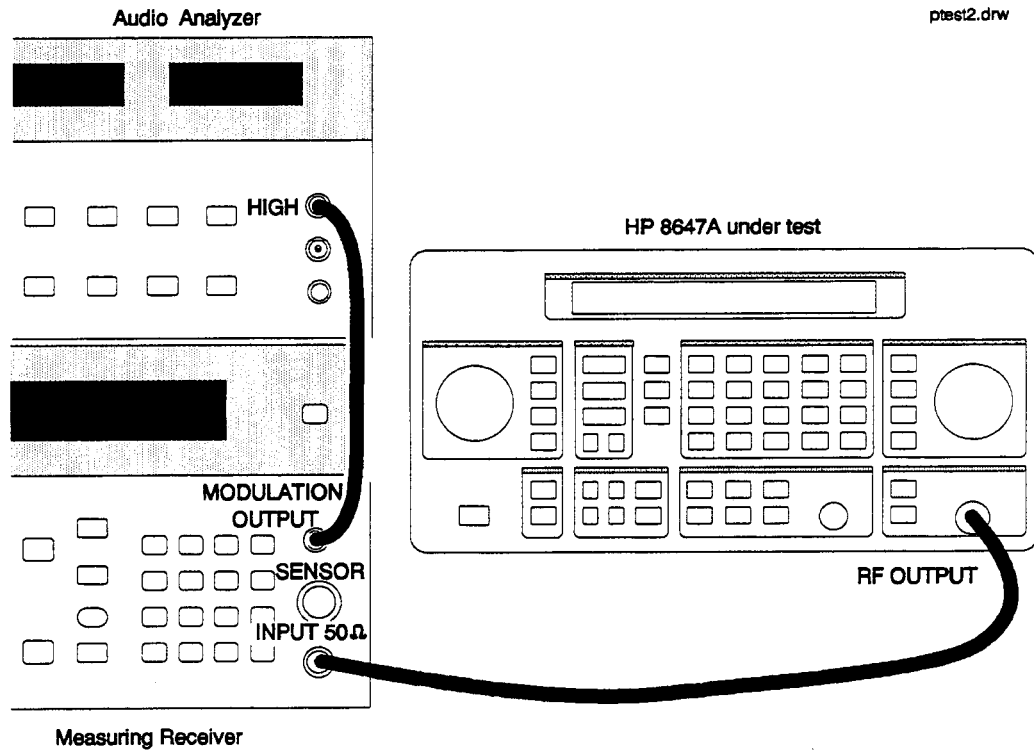

**Figure 8-4. AM Distortion Equipment Setup**

### Configure the Measuring Receiver

1. Reset
2. AM mode
3. Peak+ detector
4. 300 Hz high-pass filter
5. 15 kHz low-pass filter

### Configure the Audio Analyzer

1. Distortion mode
2. 30 kHz low-pass filter
3. Set low input to ground.

## AM Distortion Performance Test

### Configure the HP 8647A

1. Turn AM on; press **AM** **MOD ON/OFF**.
2. Set the rate; press **INT 1 kHz**.
3. Set the amplitude; press **AMPLITUDE** **4** **dB(m)**.
4. Turn the RF output on; press **RF ON/OFF**.

### Measure Distortion Amplitudes

1. Enter the amplitudes, frequencies and depths shown in the test record.
2. Record the test results and compare the results to the limits in the test record.

## Phase Modulation Accuracy Performance Test

### Connect the Test Equipment

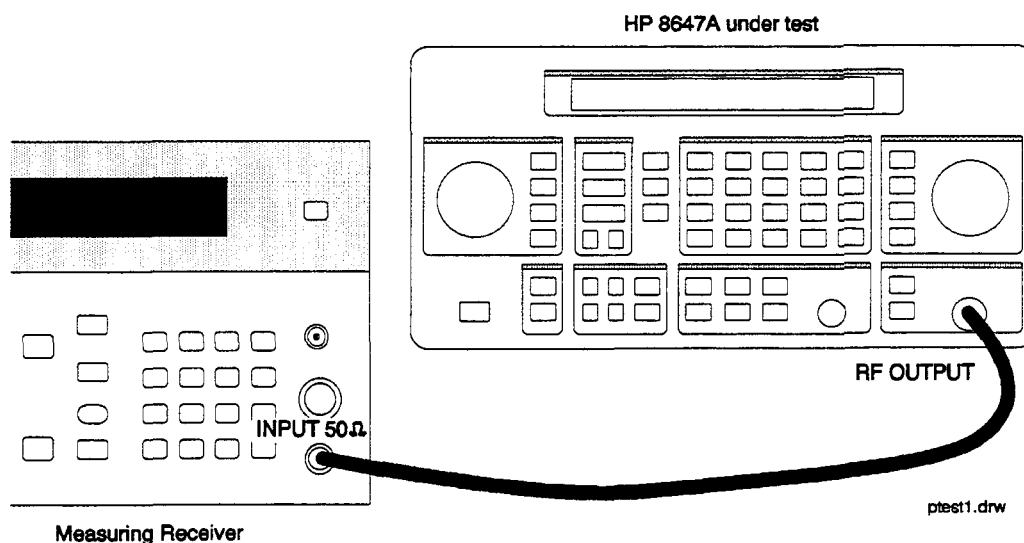

Figure 8-5. Phase Modulation Distortion Equipment Setup

#### Configure the Measuring Receiver

1. Reset
2.  $\phi$ M mode
3. Peak+ detector
4. 300 Hz high-pass filter
5. 15 kHz low-pass filter

#### Configure the HP 8647A

1. Turn  $\phi$ M on; press  **$\phi$ M** **MOD ON/OFF**.
2. Set the rate; press **INT 1 kHz**.
3. Set the amplitude; press **AMPLITUDE** **4** **dB(M)**.
4. Turn the RF output on; press **RF ON/OFF**.

#### Measure Deviations

1. Enter the frequencies and deviations shown in the test record.
2. Record the test results and compare the results to the limits in the test record.

## Phase Modulation Distortion Performance Test

### Connect the Test Equipment

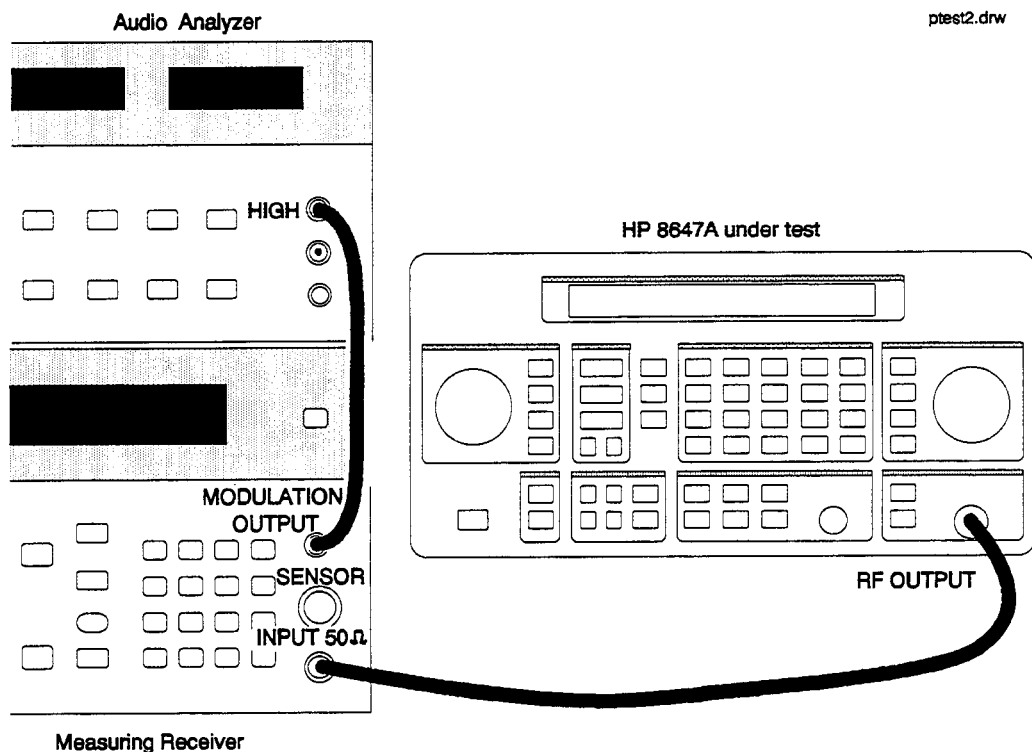

Figure 8-6. Phase Modulation Distortion Equipment Setup

#### Configure the Measuring Receiver

1. Reset
2.  $\phi$ M mode
3. Peak+ detector
4. 300 Hz high-pass filter
5. 15 kHz low-pass filter

#### Configure the Audio Analyzer

1. Distortion mode
2. 30 kHz low-pass filter
3. Set low input to ground

## Phase Modulation Distortion Performance Test

### Configure the HP 8647A

1. Turn  $\phi M$  on; press  $\Phi$  **MOD ON/OFF**.
2. Set the rate; press **INT 1 kHz**.
3. Set the amplitude; press **AMPLITUDE** **4** **dB(m)**.
4. Turn the RF output on; press **RF ON/OFF**.

### Measure Distortion

1. Enter the frequencies and deviations shown in the test record.
2. Record the test results and compare the results to the limits in the test record.

# Residual FM Performance Test

## Connect the Test Equipment

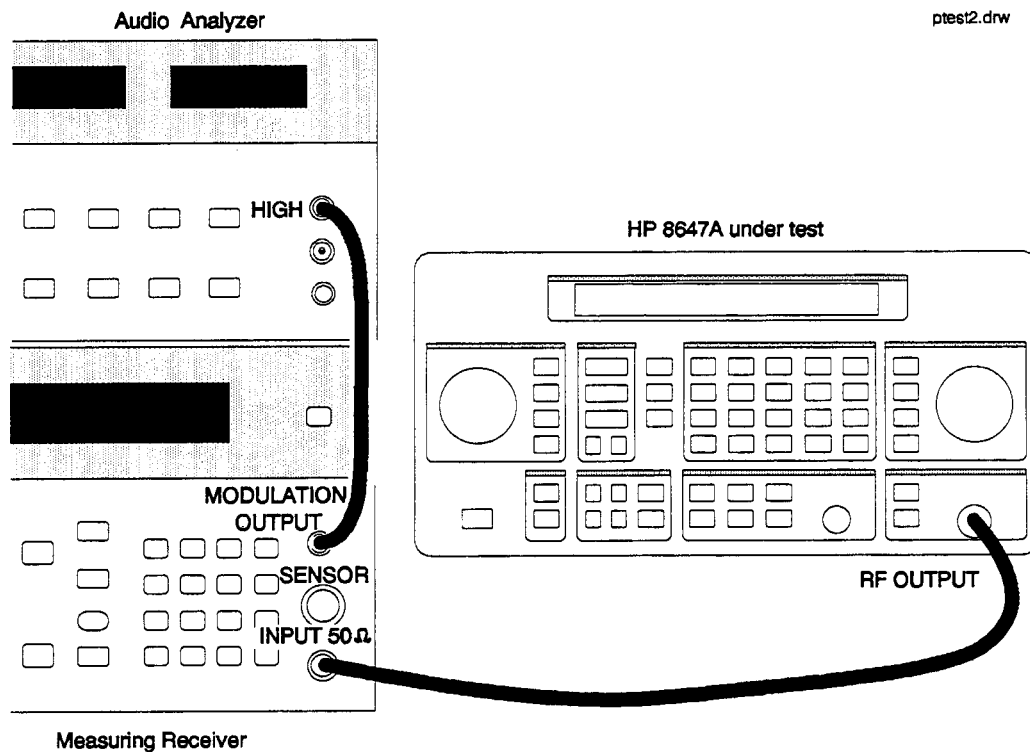

Figure 8-7. Residual FM Equipment Setup

### Configure the Measuring Receiver

1. Reset
2. FM mode
3. Peak+ detector
4. 50 Hz high-pass filter
5. 15 kHz low-pass filter

### Configure the Audio Analyzer

1. AC level mode
2. CCITT weighting filter
3. 30 kHz low-pass filter
4. Set low input to ground

**Configure the HP  
8647A**

1. Turn modulation off; press **MOD ON/OFF**.
2. Set the amplitude; press **AMPLITUDE** **4** **dB(M)**.
3. Turn the RF output on; press **RF ON/OFF**.

**Measure Deviations**

1. Enter the frequencies shown in the test record.
2. Record the test results and compare the results to the limits in the test record.

**Note**

---

The voltage displayed by the audio analyzer can be read as Hz. For example, 10 mV equals 10 Hz.

---



## Harmonics Performance Test

### Connect the Test Equipment

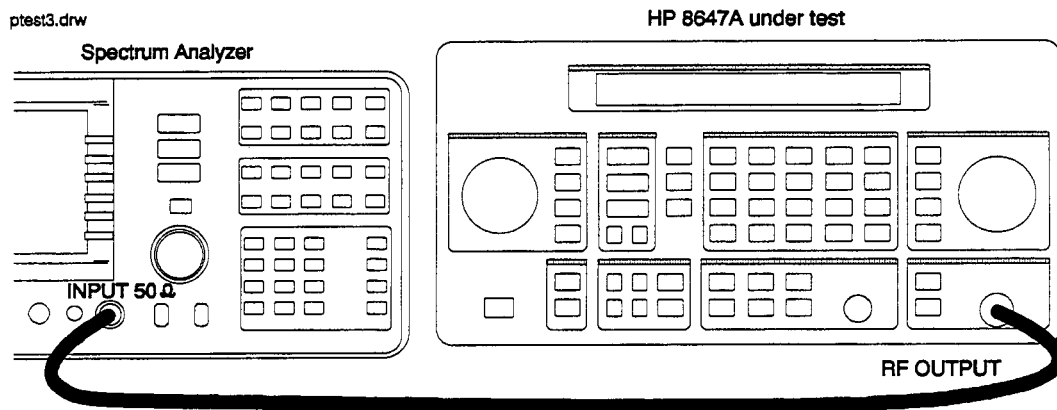

**Figure 8-8. Harmonics Equipment Setup**

#### Configure the Spectrum Analyzer

1. Frequency span: 500 kHz
2. Res BW: 10 kHz
3. Video BW: 30 kHz

#### Configure the HP 8647A

1. Turn the RF output on; press **RF ON/OFF**.
2. Turn the modulation off; press **MOD ON/OFF**.

#### Measure Harmonic Levels

1. Measure the level of the 2nd, 3rd, and 1/2 harmonics shown in the test record.
2. Convert the harmonic level to decibels below the fundamental (dBc) and compare the results to the corresponding limits.

## Spurious Performance Test

### Connect the Test Equipment

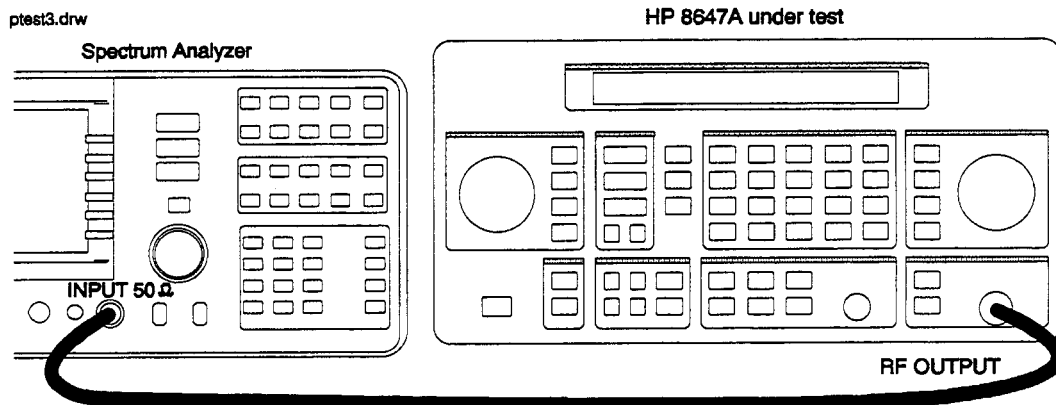

**Figure 8-9. Spurious Equipment Setup**

#### Configure the Spectrum Analyzer

1. Frequency span 500 kHz
2. Res BW 1 kHz
3. Video BW 1 kHz

#### Configure the HP 8647A

1. Turn the RF output on; press **RF ON/OFF**.
2. Turn modulation off; press **MOD ON/OFF**.

#### Measure Spurious Levels

1. Measure the levels of the spurious signals shown in the test record.
2. Convert the measured levels to decibels below the fundamental (dBc) and compare the results to the corresponding limits.

## DC FM Frequency Error Performance Test

### Connect the Test Equipment

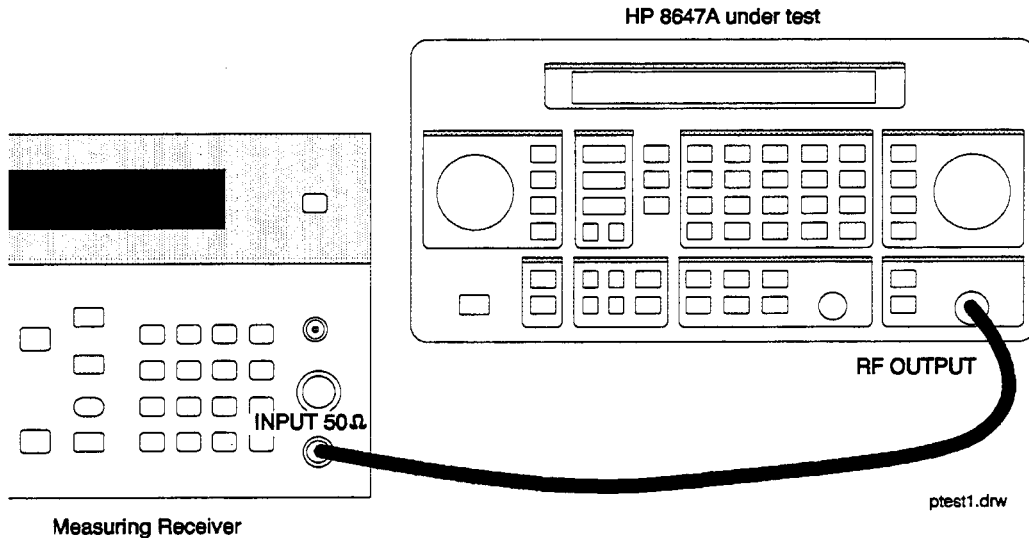

Figure 8-10. DC FM Frequency Error Equipment Setup

#### Configure the Measuring Receiver

1. Reset
2. Frequency mode
3. Special function 7.1. Press **7** **.** **1** **SPCL**.

#### Configure the HP 8647A

1. Set the amplitude; press **AMPLITUDE** **4** **dB(M)**.
2. Select external DC FM; press **FM** **EXT DC**.
3. Turn the RF output on; press **RF ON/OFF**.

#### Measure Deviations

1. Set the frequencies and deviations shown in the test record.
2. For each data point, measure the carrier frequency with FM turned off, press **MOD ON/OFF**.
3. For each data point, measure the carrier frequency with FM turned on, press **MOD ON/OFF**.
4. Compute the error (difference) and compare it to the corresponding limits in the test record.

## RF Level Accuracy Performance Test

### Connect the Test Equipment

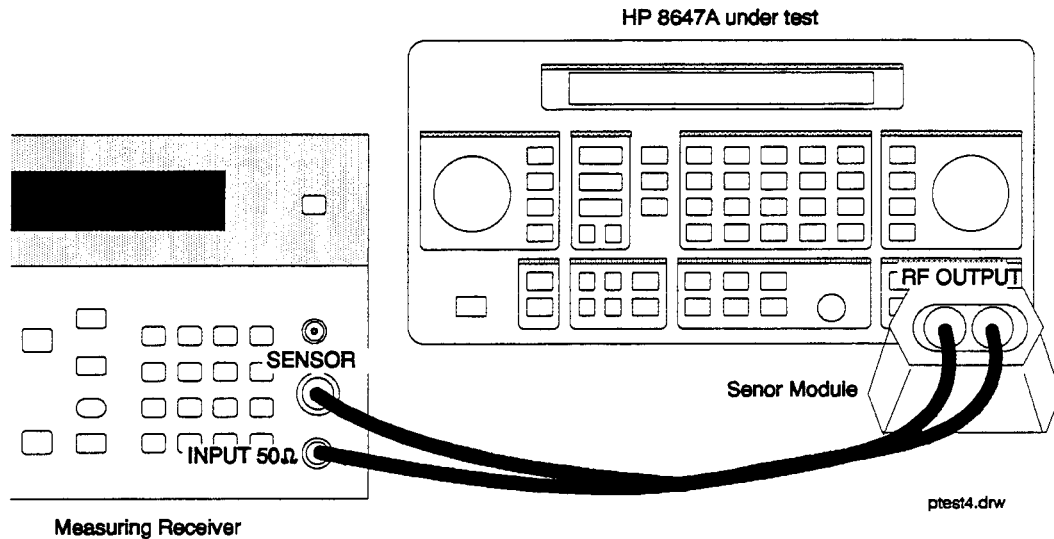

Figure 8-11. RF Level Accuracy Equipment Setup

### Configure the Measuring Receiver

1. Reset
2. RF power mode (tuned RF level mode for levels lower than  $-10$  dBm).
3. Connect the measuring receiver and HP 8647A timebases.
4. Set to measure in dBm, press **LOG/LIN**

### Note

Make sure to enter the power sensor's calibration data into the measuring receiver and zero the power sensor. Refer to the measuring receiver's operating manual.

### Configure the HP 8647A

1. Turn the RF output on; press **RF ON/OFF**.
2. Turn modulation off; press **MOD ON/OFF**.

### Measure Amplitudes

1. For each frequency the measuring receiver must be calibrated for tuned RF level operation.
2. Set the frequency and amplitude shown in the test record.
3. Measure the amplitude shown in the test record.
4. Record the test results and compare the results to the limits in the test record.

# CW Frequency Accuracy Performance Test (Option 1E5 Only)

## Connect the Test Equipment

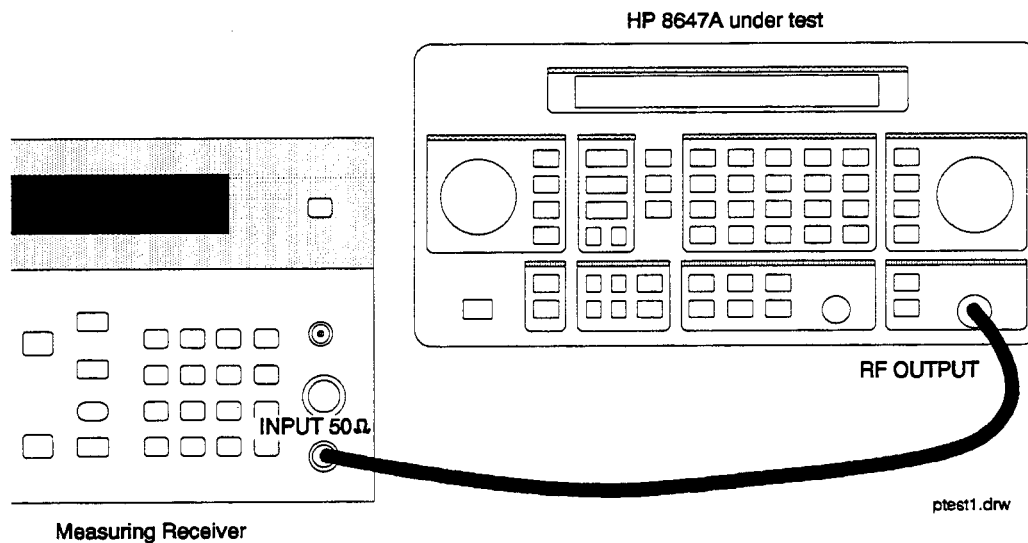

Figure 8-12. CW Frequency Accuracy Equipment Setup

### Configure the Measuring Receiver

1. Reset
2. Frequency mode
3. Special Function 7.1. Press **7** **.** **1** **SPCL**

### Configure the HP 8647A

1. Turn modulation off; press **MOD ON/OFF**.
2. Set the amplitude; press **AMPLITUDE** **4** **dB(M)**.
3. Turn the RF output on; press **RF ON/OFF**.

### Measure the Frequency

1. Enter the frequencies shown in the test record.
2. Record the test results and compare the results to the limits in the test record.

**Test Record**

**Table 8-1. HP 8647A Test Record**

Test Facility _____	Report Number _____
_____	Date _____
_____	Customer _____
_____	Tested By _____
Model _____	Ambient Temperature _____ °C
Serial Number _____	Relative Humidity _____ %
Options _____	Line Frequency _____ Hz (nominal)
Firmware Revision _____	
Special Notes:	
_____	
_____	
_____	
_____	
_____	

**Test Record**

**Table 8-2. HP 8647A Test Record**

Model _____	Report Number _____	Date _____	
Test Equipment Used	Model Number	Trace Number	Cal Due Date
1. Audio Analyzer	_____	_____	_____
2. Measuring Receiver	_____	_____	_____
3. _____	_____	_____	_____
4. _____	_____	_____	_____
5. _____	_____	_____	_____
6. _____	_____	_____	_____
7. _____	_____	_____	_____
8. _____	_____	_____	_____
9. _____	_____	_____	_____
10. _____	_____	_____	_____
11. _____	_____	_____	_____
12. _____	_____	_____	_____
13. _____	_____	_____	_____
14. _____	_____	_____	_____
15. _____	_____	_____	_____
16. _____	_____	_____	_____
17. _____	_____	_____	_____
18. _____	_____	_____	_____
19. _____	_____	_____	_____
20. _____	_____	_____	_____

Table 8-3. FM Accuracy Performance Test

Ampl dBm	Rate kHz	Freq. MHz	Dev. kHz	Limits (kHz)			Uncertainty (±Hz)
				Lower	Measured	Upper	
4	1	0.25	5	4.595		5.405	100
		0.25	10	9.220		10.780	200
		100	5	4.595		5.405	50
		100	10	9.220		10.780	100
		250	5	4.595		5.405	50
		250	10	9.220		10.780	100
		375	5	4.595		5.405	50
		375	10	9.220		10.780	100
		500	5	4.595		5.405	50
		500	10	9.220		10.780	100
		756.25	5	4.595		5.405	50
		756.25	10	9.220		10.780	100
		1000	5	4.595		5.405	50
		1000	10	9.220		10.780	100



**Test Record**

**Table 8-4. FM Distortion Performance Test**

Ampl dBm	Rate kHz	Freq. MHz	Dev. kHz	Limits (%)			Uncertainty (%)
				Lower	Measured	Upper	
4	1	10	5	0		1	0.16
		10	50	0		1	0.16
		10	100	0		1	0.16
		100	5	0		1	0.16
		100	50	0		1	0.16
		100	100	0		1	0.16
		400	5	0		1	0.16
		400	30	0		1	0.16
		400	50	0		1	0.16
		756.25	5	0		1	0.16
		756.25	50	0		1	0.16
		756.25	100	0		1	0.16
		1000	5	0		1	0.16
		1000	50	0		1	0.16
		1000	100	0		1	0.16

Table 8-5. AM Accuracy Performance Test

Ampl dBm	Rate kHz	Freq. MHz	Depth %	Limits (%)			Uncertainty (±%)
				Lower	Measured	Upper	
4	1	2	10	8		12	0.21
		2	30	27		33	0.6
		2	70	65		75	1.5
		2	90	84		96	1.9
		248	10	8		12	0.11
		248	30	27		33	0.31
		248	70	65		75	0.8
		248	90	84		96	1.0
		400	10	8		12	0.11
		400	30	27		33	0.31
		400	70	65		75	0.8
		400	90	84		96	1.0
		700	10	8		12	0.11
		700	30	27		33	0.31
		700	70	65		75	0.8
		700	90	84		96	1.0
1000	10	8		12	0.11		
1000	30	27		33	0.31		
1000	70	65		75	0.8		
1000	90	84		96	1.0		

Table 8-5.  
AM Accuracy Performance Test (continued)

Ampl dBm	Rate kHz	Freq. MHz	Depth %	Limits (%)			Uncertainty (±%)
				Lower	Measured	Upper	
-6	1	2	10	8		12	0.21
		2	30	27		33	0.6
		2	70	65		75	1.5
		2	90	84		96	1.9
		248	10	8		12	0.11
		248	30	27		33	0.31
		248	70	65		75	0.8
		248	90	84		96	1.0
		400	10	8		12	0.11
		400	30	27		33	0.31
		400	70	65		75	0.8
		400	90	84		96	1.0
		700	10	8		12	0.11
		700	30	27		33	0.31
		700	70	65		65	0.8
		700	90	84		96	1.0
		1000	10	8		12	0.11
		1000	30	27		33	0.31
		1000	70	65		75	0.8
		1000	90	84		96	1.0

Table 8-6. AM Distortion Performance Test

Ampl dBm	Rate kHz	Freq. MHz	Depth %	Limits (%)			Uncertainty (%)
				Lower	Measured	Upper	
4	1	2	30	0		2	0.39
		2	70	0		3	0.70
		2	90	0		3	0.70
		248	30	0		2	0.39
		248	70	0		3	0.70
		248	90	0		3	0.70
		400	30	0		2	0.39
		400	70	0		3	0.70
		400	90	0		3	0.70
		1000	30	0		2	0.39
		1000	70	0		3	0.70
		1000	90	0		3	0.70
-6	1	2	30	0		2	0.39
		2	70	0		3	0.70
		2	90	0		3	0.70
		248	30	0		2	0.39
		248	70	0		3	0.70
		248	90	0		3	0.70
		400	30	0		2	0.39
		400	70	0		3	0.70
		400	90	0		3	0.70
		1000	30	0		2	0.39
		1000	70	0		3	0.70
		1000	90	0		3	0.70

**Table 8-7.  
Phase Modulation Accuracy Performance Test**

Ampl. dBm	Rate kHz	Freq. MHz	Dev. Rad	Limits (rad)			Uncertainty (±rad)
				Lower	Measured	Upper	
4	1	0.250	0.5	0.4125		0.5875	0.021
		0.250	1.0	0.875		1.1250	0.041
		100	0.5	0.4125		0.5875	0.016
		100	1.0	0.875		1.1250	0.031
		400	0.5	0.4125		0.5875	0.016
		400	1.0	0.875		1.1250	0.031
		500	0.5	0.4125		0.5875	0.016
		500	1.0	0.875		1.1250	0.031
		750	0.5	0.4125		0.5875	0.016
		750	1.0	0.875		1.1250	0.031
		1000	0.5	0.4125		0.5875	0.016
		1000	1.0	0.875		1.1250	0.031

**Table 8-8.**  
**Phase Modulation Distortion Performance Test**

Ampl. dBm	Rate kHz	Freq. MHz	Dev. Rad	Limits (%)			Uncertainty (±%)
				Lower	Measured	Upper	
4	1	0.250	5	0		2	0.26
		100	5	0		2	0.26
		400	5	0		2	0.26
		500	5	0		2	0.26
		750	5	0		2	0.26
		1000	5	0		2	0.26

**Test Record**

**Table 8-9. Residual FM Performance Test**

Ampl. dBm	Freq. MHz	Limits (Hz)		Uncertainty (±Hz)
		Upper	Measured	
4	10	20		0.82
	100	20		0.82
	248	20		0.82
	251	10		0.41
	400	10		0.41
	501	20		0.82
	750	20		0.82
	1000	20		0.82

Table 8-10. Harmonics Performance Test

Ampl. dBm	Freq. MHz	Harm. #	Limits (dBc)		Uncertainty (±dB)
			Upper	Measured	
4	1	2	-30.0		1.9
	1	3	-30.0		1.9
	2	2	-30.0		1.9
	2	3	-30.0		1.9
	5	2	-30.0		1.9
	5	3	-30.0		1.9
	10	2	-30.0		1.9
	10	3	-30.0		1.9
	20	2	-30.0		1.9
	20	3	-30.0		1.9
	100	2	-30.0		1.9
	100	3	-30.0		1.9
	200	2	-30.0		1.9
	200	3	-30.0		1.9
	300	2	-30.0		1.9
	300	3	-30.0		1.9
	400	2	-30.0		1.9
	400	3	-30.0		1.9
	500	2	-30.0		1.9
	500	3	-30.0		1.9
600	2	-30.0		1.9	
700	2	-30.0		1.9	
800	2	-30.0		1.9	
900	2	-30.0		1.9	
1000	2	-30.0		1.9	



Table 8-10. Harmonics Performance Test (continued)

Ampl. dBm	Freq. MHz	Harm. #	Limits (dBc)		Uncertainty (±dB)
			Upper	Measured	
-6	1	2	-30.0		1.9
	1	3	-30.0		1.9
	2	2	-30.0		1.9
	2	3	-30.0		1.9
	5	2	-30.0		1.9
	5	3	-30.0		1.9
	10	2	-30.0		1.9
	10	3	-30.0		1.9
	20	2	-30.0		1.9
	20	3	-30.0		1.9
	100	3	-30.0		1.9
	100	3	-30.0		1.9
	200	2	-30.0		1.9
	200	3	-30.0		1.9
	300	2	-30.0		1.9
	300	3	-30.0		1.9
	400	2	-30.0		1.9
	400	3	-30.0		1.9
	500	2	-30.0		1.9
	500	3	-30.0		1.9
	600	2	-30.0		1.9
	700	2	-30.0		1.9
	800	2	-30.0		1.9
	900	2	-30.0		1.9

Table 8-10. Harmonics Performance Test (continued)

Ampl. dBm	Freq. MHz	Harm. #	Limits (dBc)		Uncertainty (±dB)
			Upper	Measured	
	1000	2	-30.0		1.9
4	501	1/2	-60.0		1.9
-6	501	1/2	-60.0		1.9
4	850	1/2	-60.0		1.9
-6	850	1/2	-60.0		1.9
4	1000	1/2	-60.0		1.9
-6	1000	1/2	-60.0		1.9

Test Record

Table 8-11. Spurious Performance Test

Ampl. dBm	Freq. MHz	Spur MHz	Limits (dBc)		Uncertainty (±dB)
			Upper	Measured	
4	242	274	-55.0		1.9
4	247	259	-55.0		1.9
-6	100	100.03	-60.0		1.9
	400	400.03	-60.0		1.9
	501	501.03	-60.0		1.9
	1000	999.97	-60.0		1.9
	100	.03	-60.0		1.9
	1	999	-60.0		1.9
	1	1000	-60.0		1.9
	11	989	-60.0		1.9
	21	979	-60.0		1.9
	41	959	-60.0		1.9
	61	939	-60.0		1.9
	81	919	-60.0		1.9
	232	304	-55.0		1.9
	242	274	-55.0		1.9
	172	312	-60.0		1.9
	227	92	-60.0		1.9
	137	315	-60.0		1.9
167	7	-60.0		1.9	
102	286	-60.0		1.9	
-6	150	149.4	-60.0		1.9
		149.6	-60.0		1.9
		149.8	-60.0		1.9
		150.2	-60.0		1.9
		150.4	-60.0		1.9
		150.6	-60.0		1.9

Table 8-12. DC FM Frequency Error Performance Test

Ampl. dBm	Freq. MHz	Dev. kHz	Freq. FM Off MHz	Freq. FM On MHz	Limits (Hz)			Uncertainty (±Hz)
					Lower	Measured	Upper	
4	100	1			-500		500	42
	100	5			-500		500	42
	100	10			-500		500	42
	500	1			-500		500	42
	500	5			-500		500	42
	500	10			-500		500	42
	1000	1			-500		500	42
	1000	5			-500		500	42
	1000	10			-500		500	42

Table 8-13. RF Level Accuracy Performance Test

Freq. MHz	Ampl. dBm	Limits (dBm)			Uncertainty (±dB)
		Lower	Measured	Upper	
3	10	8.5		11.5	.22
	4	2.5		5.5	.22
	-5.9	-7.4		-4.4	.22
	-15.9	-17.4		-14.4	.23
	-25.9	-27.4		-24.4	.23
	-35.9	-37.4		-34.4	.23
	-45.9	-47.4		-44.4	.23
	-55.9	-57.4		-54.4	.24
	-65.9	-67.4		-64.4	.24
	-75.9	-77.4		-74.4	.25
	-85.9	-87.4		-84.4	.25
	-95.9	-97.4		-94.4	.25
	-96	-97.5		-94.5	.25
	-105.9	-107.4		-104.4	.26
	-106	-107.5		-104.5	.26
	-115.9	-117.4		-114.4	.27
	-116	-117.5		-114.5	.27
	-125.9	-127.4		-124.4	.28
-126	-127.5		-124.5	.29	
-127	-128.5		-125.5	.29	

**Table 8-13.**  
**RF Level Accuracy Performance Test (continued)**

Freq. MHz	Ampl. dBm	Limits (dBm)			Uncertainty (±dB)
		Lower	Measured	Upper	
249.9	10	8.5		11.5	.22
	4	2.5		5.5	.22
	-5.9	-7.4		-4.4	.22
	-15.9	-17.4		-14.4	.23
	-25.9	-27.4		-24.4	.23
	-35.9	-37.4		-34.4	.23
	-45.9	-47.4		-44.4	.23
	-55.9	-57.4		-54.4	.24
	-65.9	-67.4		-64.4	.24
	-75.9	-77.4		-74.4	.25
	-85.9	-87.4		-84.4	.25
	-95.9	-97.4		-94.4	.25
	-96	-97.5		-94.5	.25
	-105.9	-107.4		-104.4	.26
	-106	-107.5		-104.5	.26
	-115.9	-117.4		-114.4	.27
	-116	-117.5		-114.5	.27
	-125.9	-127.4		-124.4	.28
	-126	-127.5		-124.5	.29
	-127	-128.5		-125.5	.29

**Table 8-13.**  
**RF Level Accuracy Performance Test (continued)**

Freq. MHz	Ampl. dBm	Limits (dBm)			Uncertainty (±dB)
		Lower	Measured	Upper	
400	10	8.5		11.5	.22
	4	2.5		5.5	.22
	-5.9	-7.4		-4.4	.22
	-15.9	-17.4		-14.4	.23
	-25.9	-27.4		-24.4	.23
	-35.9	-37.4		-34.4	.23
	-45.9	-47.4		-44.4	.23
	-55.9	-57.4		-54.4	.24
	-65.9	-67.4		-64.4	.24
	-75.9	-77.4		-74.4	.25
	-85.9	-87.4		-84.4	.25
	-95.9	-97.4		-94.4	.25
	-96	-97.5		-94.5	.25
	-105.9	-107.4		-104.4	.26
	-106	-107.5		-104.5	.26
	-115.9	-117.4		-114.4	.27
	-116	-117.5		-114.5	.27
	-125.9	-127.4		-124.4	.28
-126	-127.5		-124.5	.29	
-127	-128.5		-125.5	.29	

**Table 8-13.**  
**RF Level Accuracy Performance Test (continued)**

Freq. MHz	Ampl. dBm	Limits (dBm)			Uncertainty (±dB)
		Lower	Measured	Upper	
512.5	10	8.5		11.5	.22
	4	2.5		5.5	.22
	-5.9	-7.4		-4.4	.22
	-15.9	-17.4		-14.4	.23
	-25.9	-27.4		-24.4	.23
	-35.9	-37.4		-34.4	.23
	-45.9	-47.4		-44.4	.23
	-55.9	-57.4		-54.4	.24
	-65.9	-67.4		-64.4	.24
	-75.9	-77.4		-74.4	.25
	-85.9	-87.4		-84.4	.25
	-95.9	-97.4		-94.4	.25
	-96	-97.5		-94.5	.25
	-105.9	-107.4		-104.4	.26
	-106	-107.5		-104.5	.26
	-115.4	-117.4		-114.4	.27
	-116	-117.5		-114.5	.27
-125.9	-127.4		-124.4	.28	
-126	-127.5		-124.5	.29	
-127	-128.5		-125.5	.29	



**Table 8-13.**  
**RF Level Accuracy Performance Test (continued)**

Freq. MHz	Ampl. dBm	Limits (dBm)			Uncertainty (±dB)
		Lower	Measured	Upper	
999.9	10	8.5		11.5	.22
	4	2.5		5.5	.22
	-5.9	-7.4		-4.4	.22
	-15.9	-17.4		-14.4	.23
	-25.9	-27.4		-24.4	.23
	-35.9	-37.4		-34.4	.23
	-45.9	-47.4		-44.4	.23
	-55.9	-57.4		-54.4	.24
	-65.9	-67.4		-64.4	.24
	-75.9	-74.4		-74.4	.25
	-85.9	-87.4		-84.4	.25
	-95.9	-97.4		-94.4	.25
	-96	-97.5		-94.5	.25
	-105.9	-107.4		-104.4	.26
	-106	-107.5		-104.5	.26
	-115.9	-117.4		-114.4	.27
	-116	-117.5		-114.5	.27
	-125.9	-127.4		-124.4	.28
-126	-127.5		-124.5	.29	
-127	-128.5		-125.5	.29	

**Table 8-14.**  
**CW Frequency Accuracy Performance Test**  
**(Option 1E5 Only)**

Freq. MHz	Ampl. dBm	Limits (MHz)			Uncertainty (±Hz)
		Lower	Measured	Upper	
1000	4	999.9985		1000.0015	±30

# Index

---

- A**
  - A1
    - theory of operation, 5a-2
  - A2
    - theory of operation, 5a-3
    - troubleshooting, 5b-1
  - A3
    - theory of operation, 5a-3
  - A4
    - theory of operation, 5a-4
  - A5
    - theory of operation, 5a-4
  - A6
    - Part number, 6-3
    - theory of operation, 5a-4
  - A7
    - Part number, 6-3
    - theory of operation, 5a-5
  - ac power
    - connection, 3-1
  - adjustments, 6-3
  - ADRS, 1b-9
  - altitude, 3-5
  - AM, 1b-4
  - amplitude, 1a-2
    - RF OFF, 1b-18
  - amplitude , 1b-4
  - attenuator, 1b-18
    - part number, 6-2, 6-3
    - theory of operation, 5a-5
  - ATTN HOLD, 1b-18
  - audio source, 1b-16
  - auxiliary interface, 1b-21
- B**
  - backspace, 1b-6
  - book conventions, viii
  - busy, 1b-25

- C**
  - calibration cycle, 8-1
  - carton, 3-6
  - command statements and descriptions
    - HP-IB, 2-7
    - programming, 2-6
    - status reporting, 2-7
  - connection
    - ac power, 3-1
    - to other instruments, 3-5
  - container, 3-6
  - contrast, 1b-20
  - controller
    - theory of operation, 5a-3
  - conventions, viii
  - copy, 1b-25
  
- D**
  - damage, 3-1
  - delete
    - DEL**, 1a-11
  - delta, 1b-3
  - display
    - ↕, 1b-5
    - contrast, 1-2
    - REG**, 1a-6
    - SEQ**, 1a-6
    - theory of operation, 5a-2
    - Δ, 1b-3
  
- E**
  - emf, 1b-6
  - environment, 3-6
  - equipment required
    - performance tests, 8-2
  - EXT AC, 1b-16
  - EXT DC, 1b-16
  - external source, 1b-17
  
- F**
  - fan
    - part number, 6-2
  - firmware upgrade kit
    - part number, 6-2
  - FM, 1b-4
  - frequency, 1a-2, 1b-4
  - front frame kit
    - part number, 6-2
  - front panel
    - theory of operation, 5a-2
  - fuse, 3-2
  - fuse, removal, 5b-3

- G** grounding, 3-2
  
- H** help switch, 1b-21  
HI, 1b-16  
how to use this guide, viii  
HP-IB
  - address, 1b-9, 2-3
  - definition, 2-3
  - status, 1b-9
  - status reporting, 2-8humidity, 3-5
  
- I** **INCR SET**, 1a-5
  - ranges, 1b-5installation, 3-1
  - connect power cable, 3-1
  - removing the fuse, 5b-3
  - replacing the fuse, 3-2
  - shipping the signal generator, 3-6
  - storing the signal generator, 3-5
  - turn on the signal generator, 3-5
  - unpack, 3-1instrument block diagram, 5b-1  
instrument preset settings, 1b-8  
INT 1 kHz, 1b-16  
INT 400 Hz, 1b-16
  
- K** keyboard
  - theory of operation, 5a-2key representations, viii  
knob, 1-2, 1b-2
  
- L** LCD
  - theory of operation, 5a-2level
  - modulation, 1b-17line fuse
  - removal, 5b-1line module
  - part number, 6-2LO, 1b-16  
LOCAL, 1b-9
  
- M** mains fuse
  - removal, 5b-1memory, 1a-6, 1b-10
  - remote interface, 1b-23
  - sequence, 1a-7memory interface, 1b-24  
MOD INPUT/OUTPUT, 1b-17  
MOD ON/OFF, 1b-16  
modulation, 1a-3, 1b-4

- HI/LO, 1b-16
  - HP-IB, 2-10
  - input level status, 2-9
  - level, 1b-17
  - OFF, 1b-16
  - source, 1b-15, 1b-17
  - status reporting, 2-10
  - modulation distribution
    - theory of operation, 5a-3
  - motherboard
    - theory of operation, 5a-3
  - motherboard kit
    - part number, 6-2
  
- O**
  - offset, 1a-17, 1b-3
  - operation verification software, 5-2
  - ordering parts, 6-1
  - output
    - part number, 6-2, 6-3
    - theory of operation, 5a-4
  
- P**
  - packaging, 3-6
  - Parts List, 6-1
  - performance test record, 8-19
  - performance tests, 8-1
    - AM accuracy, 8-6
    - AM distortion, 8-7
    - CW frequency accuracy, 8-18
    - DC FM frequency error, 8-16
    - FM accuracy, 8-3
    - FM distortion, 8-4
    - harmonics, 8-14
    - level accuracy, 8-17
    - phase modulation accuracy, 8-9
    - phase modulation distortion, 8-10
    - required test equipment, 8-2
    - residual FM, 8-12
    - RF level accuracy, 8-17
    - spurious, 8-15
  - performance verification cycle, 8-1
  - $\phi$ M, 1b-4
  - plug, 3-4
  - $\pm$ , 1b-6
  - post regulator
    - theory of operation, 5a-3
  - power, 3-1
    - cable, 3-1, 3-4
    - memory interface, 1b-24
  - POWER
    - power key, 1-2
  - power supply
    - part number, 6-2
    - theory of operation, 5a-3
    - troubleshooting, 5b-1

- preset conditions, 1b-8
- programming
  - background, 2-1
  - command statements and descriptions, 2-6
  - guidelines, 2-3
  - language, 2-3
  - SCPI, 2-1, 2-3
  - status reporting, 2-8

**Q** query

- status reporting, 2-4

**R** rear panel, 1b-20

recall, 1a-9, 1a-15, 1b-12, 1b-14

reference

- adjustment, 6-3
- theory of operation, 5a-4

reference connectors, 1b-20

reference kit

- part number, 6-2
- REF ON/OFF**, 1b-3
- REF SET**, 1a-17, 1b-3
- REG, 1b-23
- REG**, 1-3, 1a-7, 1a-15

register, 1b-10

- delete, 1a-11
- REG**, 1a-15, 1b-12
- REG**, 1-2
- remote interface, 1b-22
- re-numbering, 1a-13
- RF output, 1b-18, 1b-19
- sequence, 1a-7
- total, 1b-12

remote interface

- memory, 1b-23

repair, 5-1

Replaceable Parts, 6-1

reverse-power, 1b-19

reverse power protection

- status reporting, 2-11

RF ON/OFF, 1b-18

RF output, 1a-2

- ON/OFF, 1a-3

RPG

- theory of operation, 5a-2

**S** safety class I, 3-1  
 safety earth ground, 3-1  
 SAVE  
     (SAV), 1-3, 1a-7  
     SAV, 1b-11  
 SCPI command reference  
     programming, 2-13  
 SCPI version, 2-20  
 (SEQ), 1a-7  
 sequence  
     SEQ, 1b-13, 1b-23  
     total, 1b-10  
 service information, 5-1  
 service support software  
     part number, 6-2  
 shipping instructions, 5-1  
 shipping the signal generator, 3-6  
 sig gen synth  
     theory of operation, 5a-4  
 sig gen synth kit  
     part number, 6-2  
 sign, 1b-6  
 simplified block diagram, 5a-1  
 software  
     operation verification, 5-2  
 source, 1b-15, 1b-17  
 special function representations, viii  
 status reporting  
     clearing status, 2-10  
     HP-IB, 2-8  
     programming, 2-8  
     query instrument settings, 2-4  
     unspecified power entry status, 2-11  
 storing, 3-5  
 synthesizer  
     theory of operation, 5a-4

**T** temperature, 3-5  
 terminate, 1b-10  
 test record, 8-19  
 theory of operation, 5a-1  
     10 Mhz, 5a-4  
     A1, 5a-2  
     A2, 5a-3  
     A3, 5a-3  
     A4, 5a-4  
     A5, 5a-4  
     A6, 5a-4  
     A7, 5a-5  
     attenuator, 5a-5  
     controller, 5a-3  
     display, 5a-2  
     front panel, 5a-2  
     keyboard, 5a-2



LCD, 5a-2  
modulation distribution, 5a-3  
motherboard, 5a-3  
output, 5a-4  
post regulator, 5a-3  
power supply, 5a-3  
reference, 5a-4  
RPG, 5a-2  
sig gen synth, 5a-4  
synthesizer, 5a-4  
timebase, 1b-20  
    adjustment, 6-3  
TIMEBASE ADJUST, 1b-21

**U** units conversion, 1b-6

**V** vernier, 1b-18